

HONDA
MARINE

BF25D•BF30D Owner's Manual

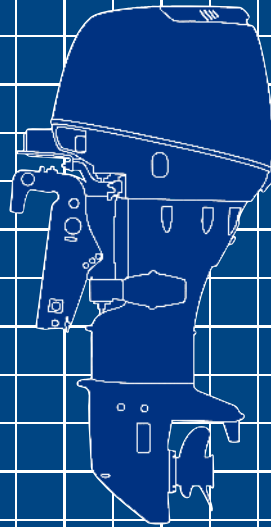



WARNING:



The engine exhaust from this product contains chemicals known to the State of California to cause cancer, birth defects, or other reproductive harm.

Keep this owner's manual handy, so you can refer to it at any time. This owner's manual is considered a permanent part of the outboard motor and should remain with the outboard motor if resold.

The information and specifications included in this publication were in effect at the time of approval for printing. Honda Motor Co., Ltd. reserves the right, however, to discontinue or change specifications or design at any time without notice and without incurring any obligation whatever. No part of this publication may be reproduced without written permission.

INTRODUCTION

Congratulations on your selection of a Honda outboard motor. We are certain you will be pleased with your purchase of one of the finest outboard motors on the market.

We want to help you get the best results from your new outboard motor and to operate it safely. This manual contains information on how to do that; please read it carefully.

As you read this manual you will find information preceded by a

NOTICE symbol. That information is intended to help you avoid damage to your outboard motor, other property, or the environment.

We suggest you read the warranty policy to fully understand its coverage and your responsibilities of ownership.

When your outboard motor needs scheduled maintenance, keep in mind that your Honda marine dealer is specially trained in servicing Honda outboard motors. Your Honda marine dealer is dedicated to your satisfaction and will be pleased to answer your questions and concerns.

Best Wishes,
Honda Motor Co., Ltd.

INTRODUCTION

A FEW WORDS ABOUT SAFETY

Your safety and the safety of others are very important. And using this outboard motor safely is an important responsibility.

To help you make informed decisions about safety, we have provided operating procedures and other information on labels and in this manual. This information alerts you to potential hazards that could hurt you or others.

Of course, it is not practical or possible to warn you about all the hazards associated with operating or maintaining an outboard motor. You must use your own good judgment.

You will find important safety information in a variety of forms, including:

- **Safety Labels** — on the outboard motor.
- **Safety Messages** — preceded by a safety alert symbol  and one of three signal words, DANGER, WARNING, or CAUTION.

These signal words mean:

 You **WILL** be **KILLED** or **SERIOUSLY HURT** if you don't follow instructions.

 You **CAN** be **KILLED** or **SERIOUSLY HURT** if you don't follow instructions.

 You **CAN** be **HURT** if you don't follow instructions.

- **Safety Headings** — such as *IMPORTANT SAFETY INFORMATION*.
- **Safety Section** — such as *OUTBOARD MOTOR SAFETY*.
- **Instructions** — how to use this outboard motor correctly and safely.

This entire book is filled with important safety information — please read it carefully.

CONTENTS

OUTBOARD MOTOR SAFETY.....	7	Gearshift/Throttle Control Lever	
IMPORTANT SAFETY INFORMATION.....	7	(side-mount type).....	22
SAFETY LABEL LOCATIONS.....	9	Common Controls.....	23
CONTROLS AND FEATURES	10	Power Trim/Tilt Switch	
CONTROL AND FEATURE		(SRT and LRT types) (side-mount type).....	23
IDENTIFICATION CODES	10	(LHT type)	23
COMPONENT AND CONTROL LOCATIONS.....	11	Power Tilt Switch (LHT, SRT and LRT types).....	23
CONTROLS.....	16	Manual Relief Valve	
SH, LH, SHG and LHT Types (long tiller handle)		(LHT, SRT and LRT types).....	24
Recoil Starter Grip (SH and LH types).....	16	Tilt Lock Lever	
Ignition Switch (SHG and LHT types).....	16	(SHG, LHT, SRG, LRG, SRT	
Emergency Stop Switch and Switch Clip.....	17	and LRT types)	24
Throttle Grip.....	17	Engine Cover Latches	24
Throttle Friction Adjuster	18	Transom Angle Adjusting Rod.....	25
Gearshift Lever	18	Trim Tab.....	25
Steering Friction Adjuster.....	18	INSTRUMENTS.....	26
Tilt Lever		Trim Meter (optional equipment)	26
(manual tilt/SH and LH types).....	19	Tachometer (optional equipment).....	26
(gas assist tilt/SHG, SRG		Fuel Gauge	26
and LRG types)	19	INDICATORS.....	27
SRG, LRG, SRT and LRT Types (remote control)		Oil Pressure Indicator.....	27
Ignition Switch (side-mount type).....	20	Overheat Indicator.....	28
Emergency Stop Switch and Switch Clip		Cooling System Indicator	28
(side-mount type)	20		
Fast Idle Lever (side-mount type).....	21		

CONTENTS

OTHER FEATURES	29	STARTING THE ENGINE	43
Anodes.....	29	SH, LH, SHG and LHT Types	
Overrev Limiter.....	30	(long tiller handle).....	43
Portable Fuel Tank	30	SRG, LRG, SRT and LRT Types	
Fuel Filler Cap Vent Knob.....	30	(remote control).....	46
Fuel Priming Bulb.....	31	EMERGENCY STARTING.....	48
INSTALLATION.....	32	STOPPING THE ENGINE.....	51
POWER REQUIREMENTS.....	32	Emergency Engine Stopping	51
BOAT TRANSOM REQUIREMENTS	32	Normal Engine Stopping.....	51
INSTALLATION POSITION	32	GEARSHIFTING AND	
ATTACHMENT	33	THROTTLE OPERATION	53
TRANSOM ANGLE ADJUSTMENT	34	SH, LH, SHG and LHT Types	
BATTERY CONNECTIONS.....	34	(long tiller handle).....	53
BEFORE OPERATION.....	37	SRG, LRG, SRT and LRT Types	
ARE YOU READY TO GET UNDER WAY ?	37	(remote control).....	54
IS YOUR OUTBOARD MOTOR		STEERING	55
READY TO GO ?	37	SH, LH, SHG and LHT Types	
OPERATION	39	(long tiller handle).....	55
SAFE OPERATING PRECAUTIONS	39	Steering Friction Adjuster.....	55
BREAK-IN PROCEDURE.....	39	SRG, LRG, SRT and LRT Types	
TRANSOM ANGLE ADJUSTMENT	40	(remote control).....	55
PORTABLE FUEL TANK.....	42	CRUISING	56
FUEL HOSE CONNECTIONS.....	42	TRIM TAB	58
FUEL PRIMING.....	43	SHALLOW WATER OPERATION	58
		MOORING, BEACHING, LAUNCHING.....	61

CONTENTS

SERVICING YOUR OUTBOARD MOTOR.....	64	STORAGE	85
THE IMPORTANCE OF MAINTENANCE.....	64	STORAGE PREPARATION	85
MAINTENANCE SAFETY	65	Cleaning and Flushing	85
SPARE EMERGENCY STOP SWITCH CLIP AND		Fuel.....	88
EMERGENCY STARTER ROPE.....	66	Engine Oil	90
TOOL KIT.....	66	STORAGE PRECAUTIONS	90
MAINTENANCE SCHEDULE	67	REMOVAL FROM STORAGE.....	91
TRIM TAB ADJUSTMENT	69		
MANUAL RELIEF VALVE.....	70	TRANSPORTING	92
ENGINE COVER REMOVAL AND		WITH OUTBOARD MOTOR INSTALLED	
INSTALLATION	70	ON BOAT	92
Engine Oil Level Check.....	71	WITH OUTBOARD MOTOR REMOVED	
Engine Oil Change	72	FROM BOAT	93
Engine Oil Recommendations	73		
Lubrication Points	74		
Spark Plug Service	75		
REFUELING.....	77		
FUEL RECOMMENDATIONS.....	78		
Fuel Filter Inspection and Replacement	79		
Portable Fuel Tank and Filter Cleaning	81		
Anode Replacement	82		
Propeller Replacement	84		

CONTENTS

TAKING CARE OF UNEXPECTED

PROBLEMS.....	95
ENGINE WILL NOT START.....	96
HARD STARTING OR STALLS AFTER STARTING.....	98
ENGINE OVERHEATS.....	99
BATTERY WILL NOT CHARGE AND ELECTRIC STARTER WILL NOT OPERATE.....	100
Fuse Replacement.....	100
OIL PRESSURE INDICATOR LIGHT GOES OFF AND ENGINE SPEED IS LIMITED.....	101
OVERHEAT INDICATOR LIGHT COMES ON AND ENGINE SPEED IS LIMITED.....	102
SUBMERGED MOTOR.....	103

TECHNICAL AND CONSUMER

INFORMATION.....	105
TECHNICAL INFORMATION.....	105
Serial Number Locations.....	105
Carburetor Modification for High Altitude Operation.....	106
Battery.....	106
Oxygenated Fuels.....	107
Emission Control System Information.....	108
Star Label.....	110
Specifications.....	112
CONSUMER INFORMATION.....	116
Honda Publications.....	116
Customer Service Information.....	116
Distributor's Limited Warranty — 2006.....	119
Emission Control System Warranty.....	123

INDEX.....	127
------------	-----

WIRING DIAGRAMS.....	Inside Back Cover
----------------------	-------------------

OUTBOARD MOTOR SAFETY

IMPORTANT SAFETY INFORMATION

Honda BF25D and BF30D outboard motors are designed for use with boats that have a suitable manufacturer's power recommendation. Other uses can result in injury to the operator or damage to the outboard motor and other property.

Most accidents can be prevented if you follow all instructions in this manual and on the outboard motor. The most common hazards are discussed below, along with the best way to protect yourself and others.

Operator Responsibility

- It is the operator's responsibility to provide the necessary safeguards to protect people and property. Know how to stop the engine quickly in case of emergency. Understand the use of all controls.
- Stop the engine immediately if anyone falls overboard, and do not run the engine while the boat is near anyone in the water.
- Always stop the engine if you must leave the controls for any reason.
- Attach the emergency stop switch lanyard securely to the operator.
- Always wear a PFD (Personal Flotation Device) while on the boat.
- Familiarize yourself with all laws and regulations relating to boating and the use of outboard motors.
- Be sure that anyone who operates the outboard motor receives proper instruction.
- Be sure the outboard motor is properly mounted on the boat.
- Do not remove the engine cover while the engine is running.

OUTBOARD MOTOR SAFETY

Refuel With Care

- Gasoline is extremely flammable, and gasoline vapor can explode. Refuel outdoors, in a well-ventilated area, with the engine stopped. Never smoke near gasoline, and keep other flames and sparks away.
- Remove any portable fuel tank from the boat for refueling. Keep the portable fuel tank away from the battery or other potential spark sources.
- Refuel carefully to avoid spilling fuel. Avoid overfilling the fuel tank.
- After refueling, tighten the filler cap securely. If any fuel is spilled, make sure the area is dry before starting the engine.

Carbon Monoxide Hazard

Exhaust gas contains poisonous carbon monoxide. Avoid inhalation of exhaust gas. Never run the engine in a closed garage or confined area.

OUTBOARD MOTOR SAFETY

SAFETY LABEL LOCATIONS

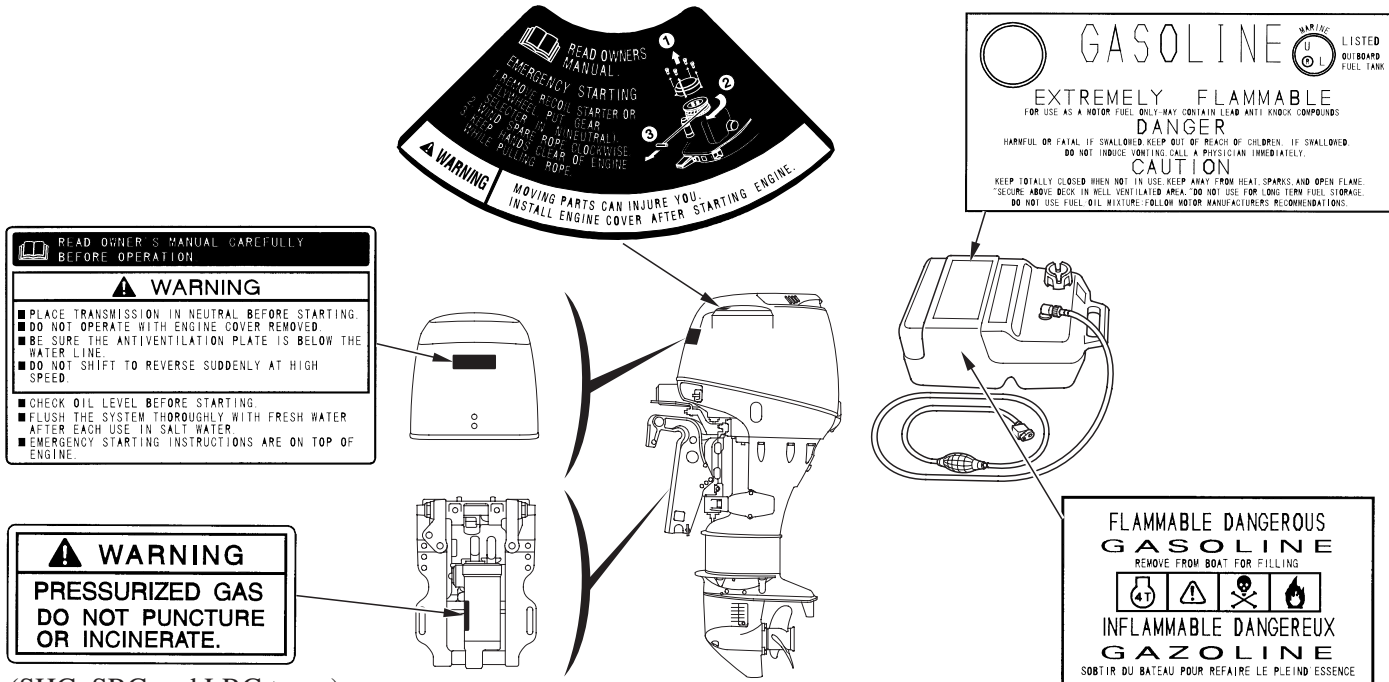

(SHG, SRG and LRG types)

The labels shown here contain important safety information. Please read them carefully. These labels are considered permanent parts of your outboard motor. If a label comes off or becomes hard to read, contact an authorized Honda marine dealer for a replacement.

CONTROLS AND FEATURES

COMPONENT AND CONTROL LOCATIONS SH, LH, SHG and LHT Types (long tiller handle)

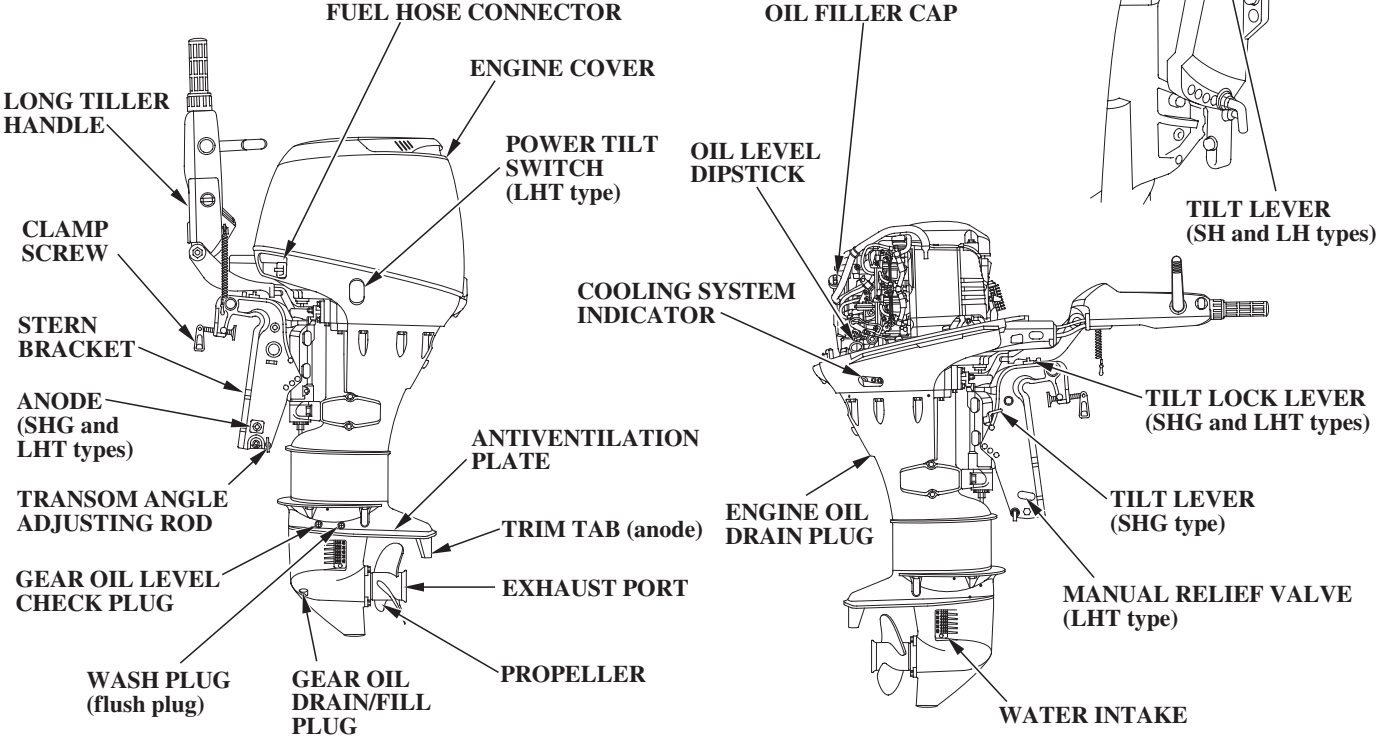

CONTROLS AND FEATURES

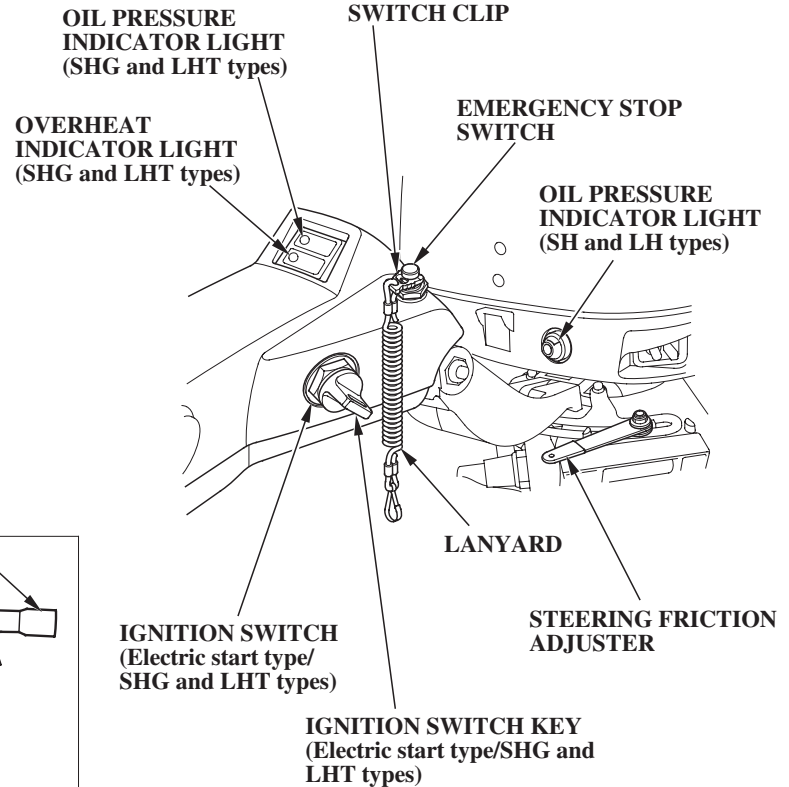
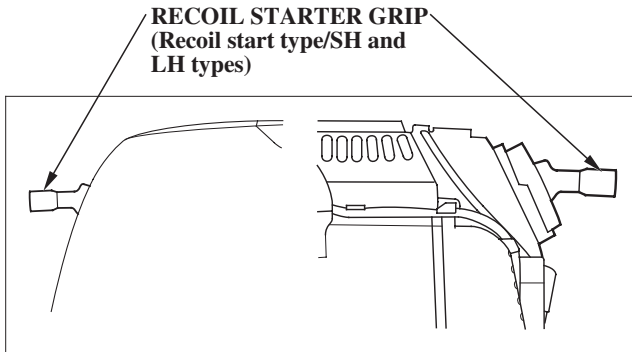
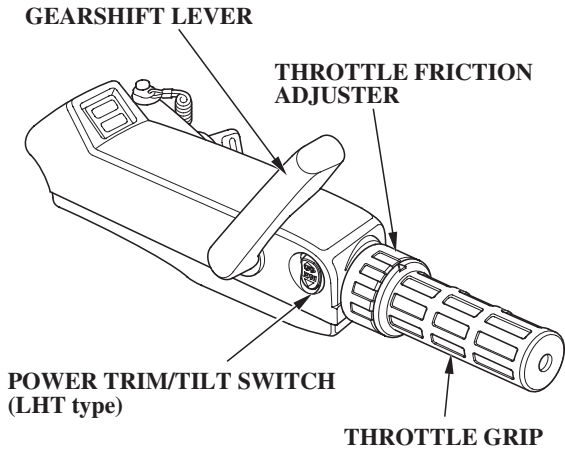

CONTROLS AND FEATURES

SRG, LRG, SRT and LRT Types (remote control)

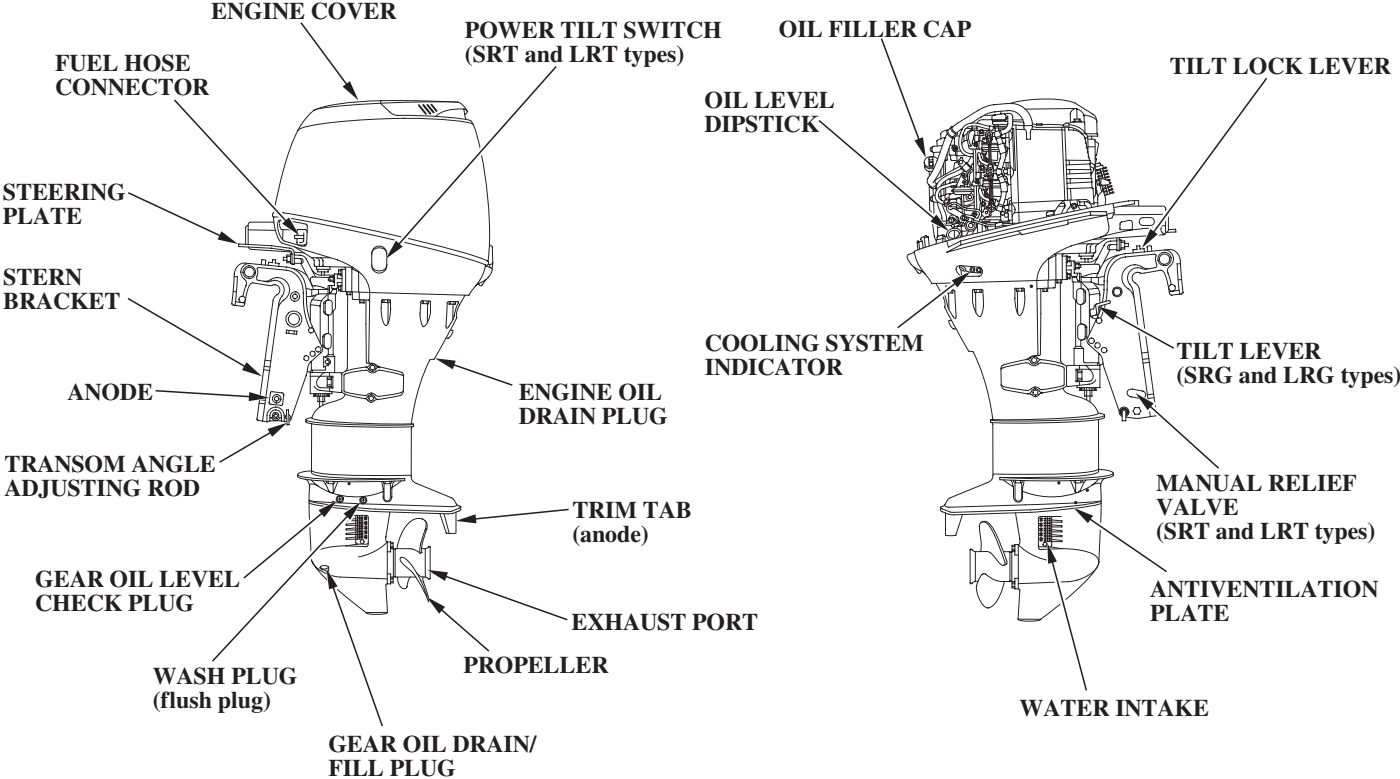

CONTROLS AND FEATURES

Remote Control box (side-mount type)

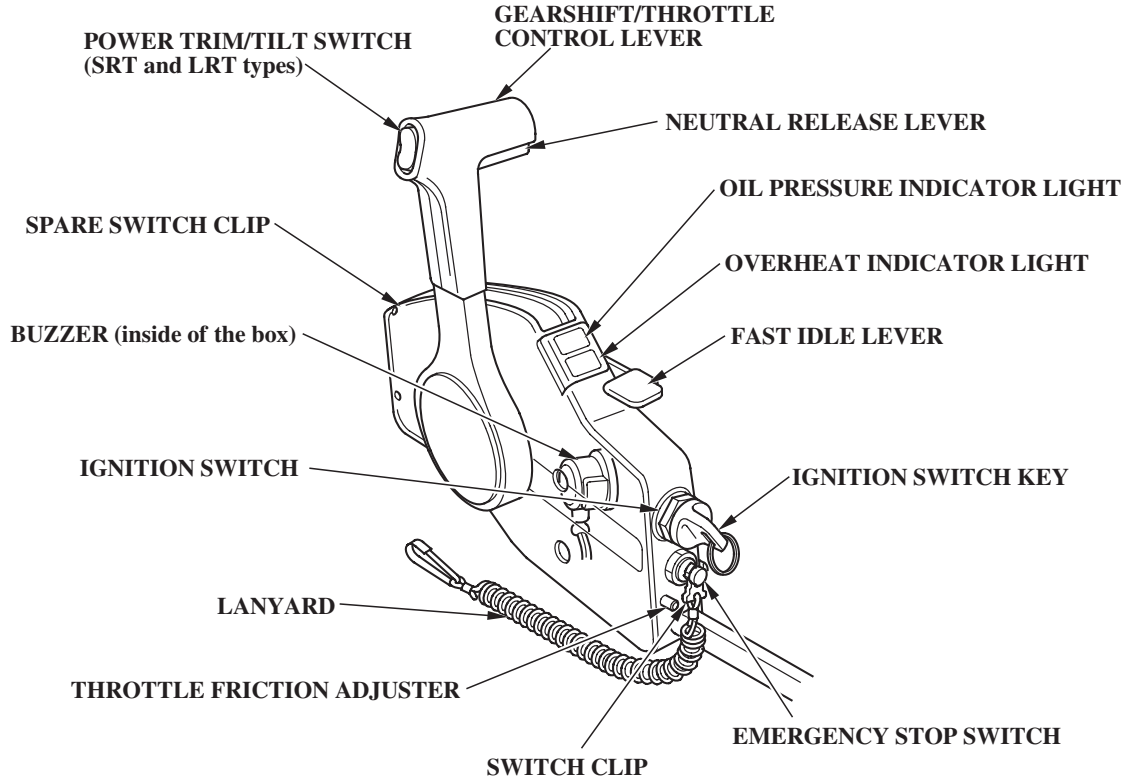

Fuel Tank

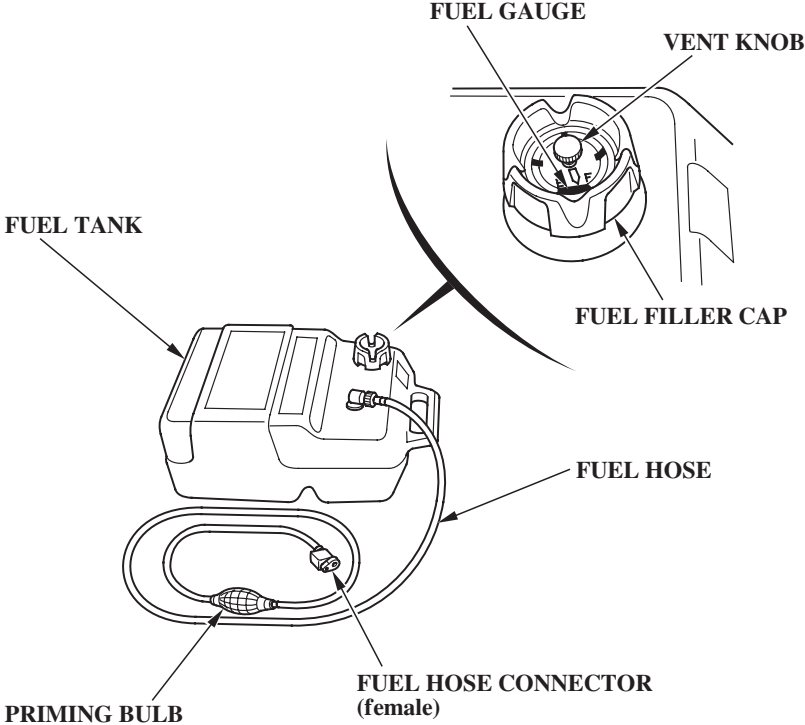

Tachometer

[optional equipment (SHG, LHT, SRG, LRG, SRT and LRT Types)]

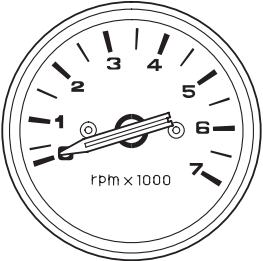

Trim Meter

[optional equipment (SRT and LRT Types)]

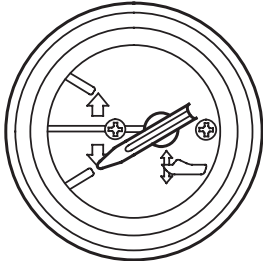

CONTROLS AND FEATURES

CONTROLS

**SH, LH, SHG and LHT Types
(long tiller handle)**

***Recoil Starter Grip
(SH and LH types)***

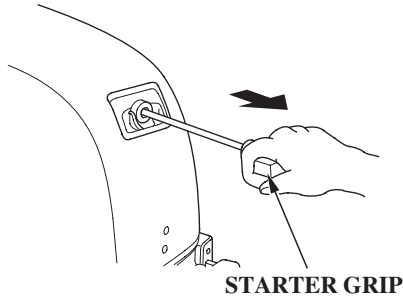

Pull the starter grip to operate the recoil starter for starting the engine manually.

The engine will not start unless the gearshift lever is in the N (neutral) position (p. 44), and the clip is in the engine stop switch.

***Ignition Switch
(SHG and LHT types)***

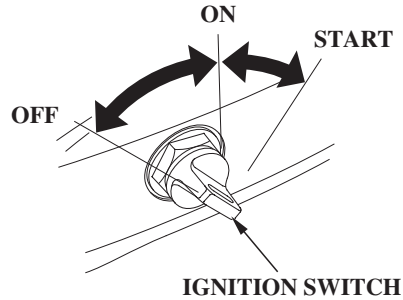

The ignition switch controls the ignition system and starter motor.

Turning the ignition switch key to the START position operates the starter motor. The key automatically returns to the ON position when released from the START position.

The ignition switch can be used to start the engine only when the gearshift lever is in the N (neutral) position (p. 44), and the switch clip is in the emergency stop switch.

Turning the ignition switch to the OFF position stops the engine.

Emergency Stop Switch and Switch Clip

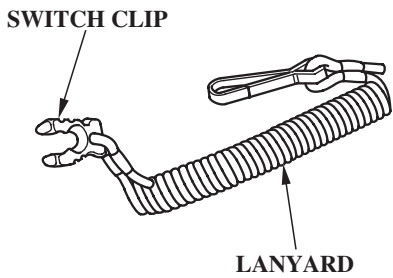
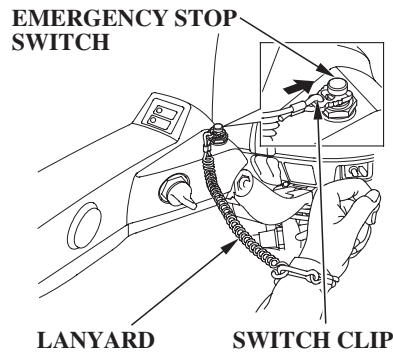

The switch clip must be inserted in the engine stop switch in order for the engine to start and run. The lanyard should be attached to the operator's PFD (Personal Flotation Device) or worn around the wrist as shown.

When used as described, the emergency stop switch and lanyard system stops the engine if the operator falls away from the controls.

A spare switch clip is supplied with the motor (p. 66).

Throttle Grip

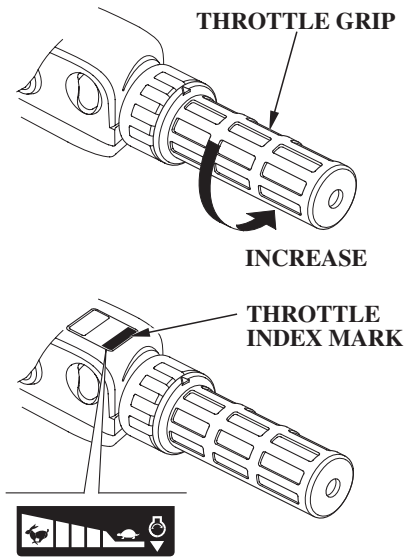

The throttle grip controls engine speed.

An index mark on the tiller arm shows throttle position and is helpful for setting the throttle correctly when starting (p. 44).

CONTROLS AND FEATURES

Throttle Friction Adjuster

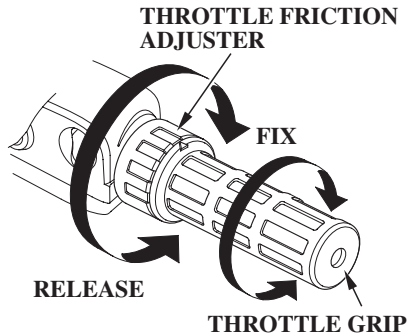

The throttle friction adjuster adjusts resistance to throttle grip rotation.

Turn the adjuster clockwise to increase friction for holding a throttle setting while cruising.

Turn the adjuster counterclockwise to decrease friction for easy throttle grip rotation.

Gearshift Lever

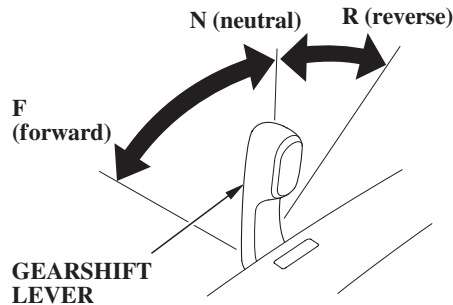

The gearshift lever is used to select F (forward), N (neutral), or R (reverse) gears.

The engine can be started with the gearshift lever in the N (neutral) position only.

Steering Friction Adjuster

(SH and LH types)

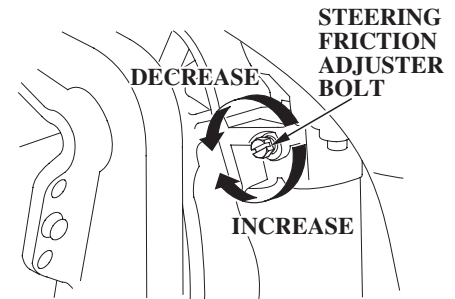

(SHG and LHT types)

STEERING FRICTION ADJUSTER

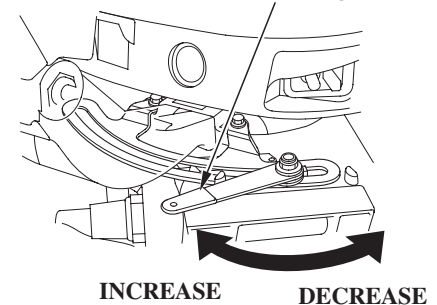

The steering friction adjuster adjusts steering resistance.

Less friction allows the outboard motor to turn more easily. More friction helps to hold steady course while cruising or to prevent the outboard motor from swinging while trailering the boat.

Tilt Lever (manual tilt/SH and LH types)

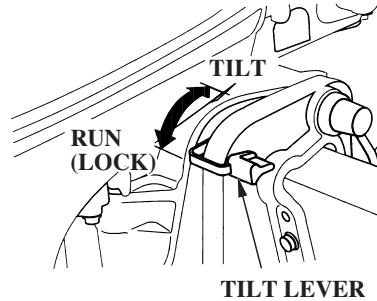

The tilt lever enables the outboard motor to be raised for shallow water operation, beaching, launching, or mooring.

To tilt, move the lever to the TILT position, then raise the outboard motor until the tilt mechanism engages at 20° 37°, 67° (Transom angle at 12°) (p. 60 and 61).

(gas assist tilt/SHG, SRG and LRG types)

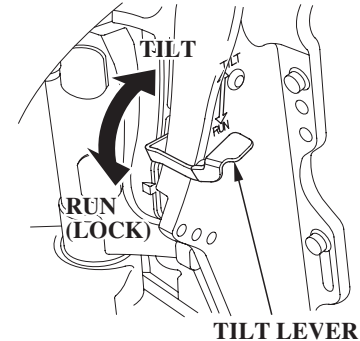

Moving the tilt lever to the TILT position allows the outboard motor to be tilted and moving the tilt lever to the RUN (LOCK) position locks the outboard motor in the desired position. Use the tilt lever to temporarily tilt the outboard motor when the boat is operating in shallow water, or mooring in shallow water. The tilt lever must be in the RUN (LOCK) position before operating the outboard motor or the motor could tilt up when operating in reverse.

CONTROLS AND FEATURES

SRG, LRG, SRT and LRT Types (remote control)

For panel mount or top mount remote control information, refer to the instructions provided with the remote control equipment.

Ignition Switch (side-mount type)

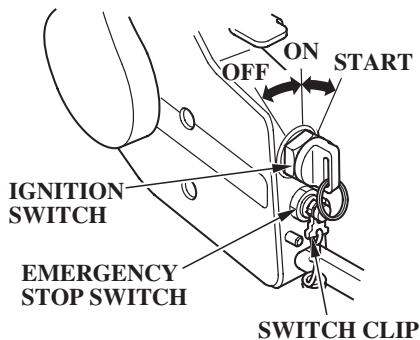

The ignition switch controls the ignition system and starter motor.

Turning the ignition switch key to the START position operates the starter motor. The key automatically returns to the ON position when released from the START position.

The ignition switch can be used to start the engine only when the gearshift lever is in the N (neutral) position (p. 46), and the switch clip is in the emergency stop switch.

Turning the ignition switch to the OFF position stops the engine.

Emergency Stop Switch and Switch Clip (side-mount type)

EMERGENCY STOP SWITCH

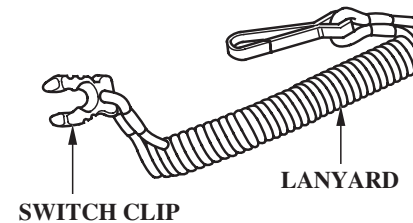
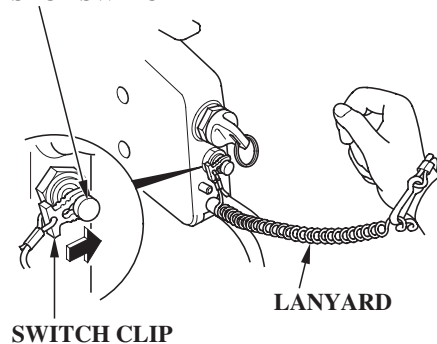

The switch clip must be inserted in the emergency stop switch in order for the engine to start and run. The lanyard must be attached to the operator's PFD (Personal Flotation Device) or worn around the wrist as shown.

When used as described, the emergency stop switch and lanyard system stops the engine if the operator falls away from the controls.

A spare switch clip is stored in a slot in the control housing.

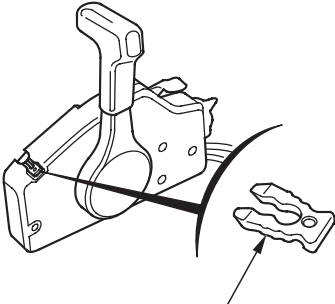

SPARE SWITCH CLIP

Fast Idle Lever (side-mount type)

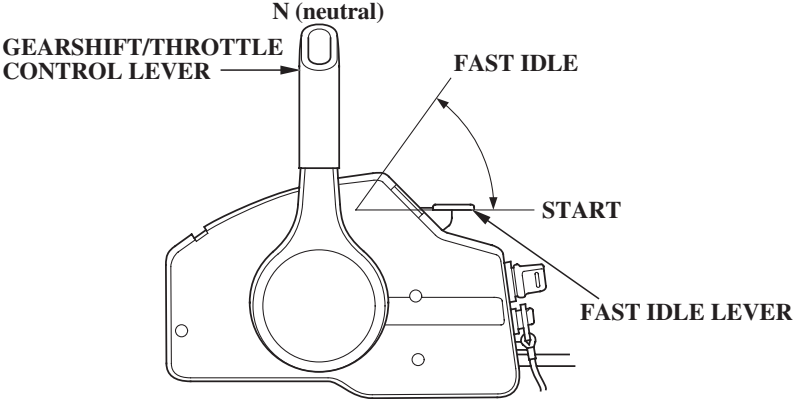

The fast idle lever is used to set idle speed during warm-up.

The lever will not move unless the gearshift/throttle control lever is in the N (neutral) position. The fast idle lever must be in its lowest position for you to move the gearshift/throttle control lever out of neutral.

Leave the fast idle lever in the START position to provide a rich fuel mixture for starting a cold engine.

Lift the fast idle lever to accelerate the warm up of a cold engine after starting and to start a warm engine.

CONTROLS AND FEATURES

Gearshift/Throttle Control Lever (side-mount type)

GEARSHIFT/THROTTLE CONTROL LEVER

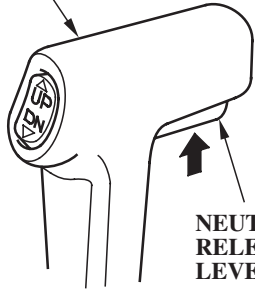

NEUTRAL RELEASE LEVER

The control lever automatically locks itself in the N (neutral) position. To move the lever out of the N (neutral) position, you must squeeze the neutral release lever on the underside of the lever handle.

GEARSHIFT/THROTTLE CONTROL LEVER

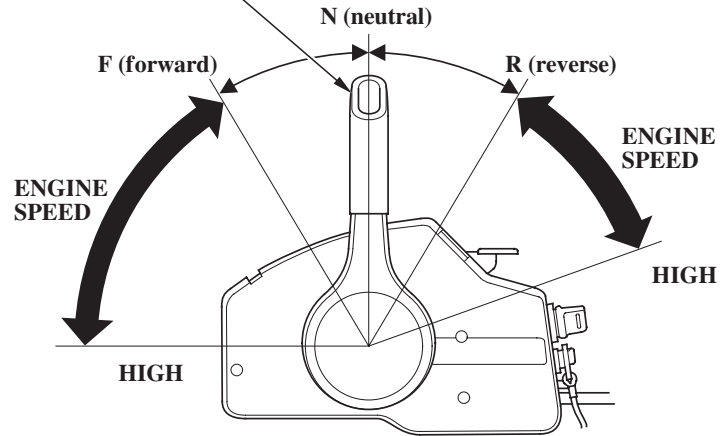

The gearshift/throttle control lever controls engine speed and selects F (forward), N (neutral), or R (reverse) gears.

Moving the control lever 30° from N (neutral) selects the gear, and further movement increases engine speed.

A friction adjuster near the base of the control lever adjusts the operating resistance of the control lever (p. 54).

Less friction allows easier control lever movement. More friction helps to hold a steady throttle setting while cruising.

Common Controls

Power Trim/Tilt Switch

[SRT and LRT types (side-mount type)]

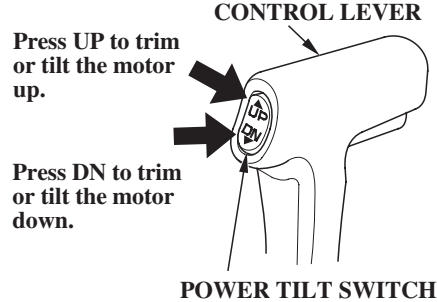

(LHT type)

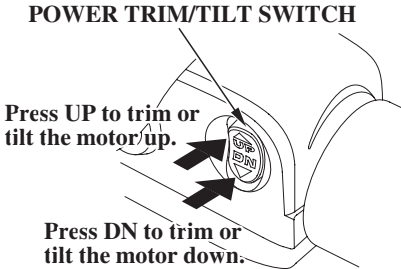

The power trim/tilt switch is located on the control lever or the tiller handle. It is a rocker switch with UP and DN (down) positions for changing the angle of the outboard motor.

You can use the power tilt switch anytime the ignition switch is ON, whether the boat is underway or stopped.

Trim the outboard motor to obtain the best performance and stability (p. 56).

Tilt the outboard motor for shallow water operation, beaching, launching, or mooring.

Power Tilt Switch (LHT, SRT and LRT types)

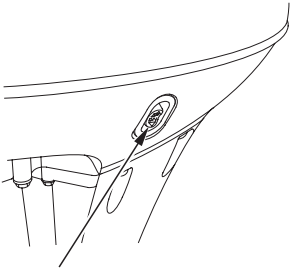

POWER TILT SWITCH

The power tilt switch is located on the engine pan. It is a rocker switch with UP and DN (down) positions for changing the angle of the outboard motor.

The power tilt switch will operate without turning the ignition switch ON.

This switch is used with the engine stopped to raise the outboard motor for mooring, trailering or maintenance.

CONTROLS AND FEATURES

Manual Relief Valve (LHT, SRT and LRT types)

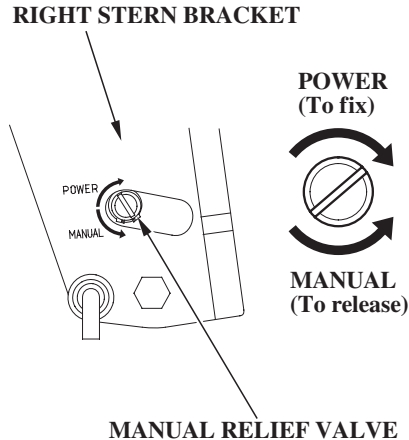

The outboard motor can be tilted manually after opening the manual relief valve. This allows the outboard motor to be tilted when no battery is connected.

Tilt Lock Lever (SHG, LHT, SRG, LRG, SRT and LRT types)

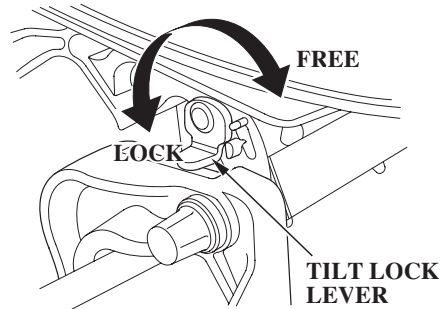

The tilt lock lever is used to support the outboard motor in the fully-raised position.

When the boat is to be moored for a long time, tilt the outboard motor as far as it will go. Then move the tilt lock lever to the LOCK position, and gently lower the outboard motor until the lever contacts the stern bracket.

Engine Cover Latches

REAR

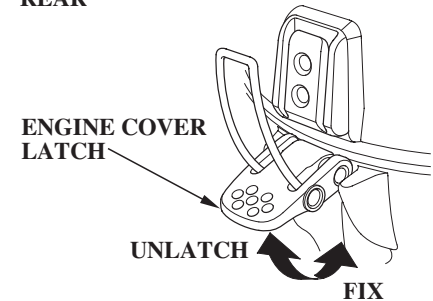

FRONT

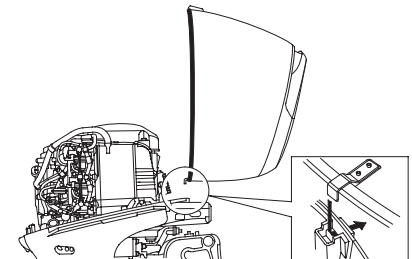

The engine cover latches fasten the engine cover to the outboard motor.

Transom Angle Adjusting Rod (SH and LH types)

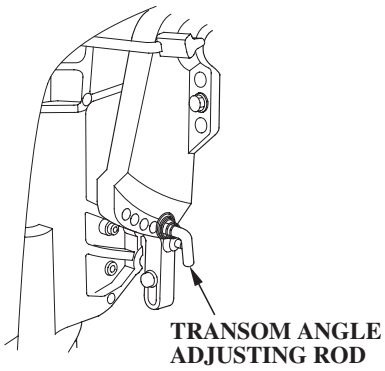

(SHG, LHT, SRG, SRT and LRT types)

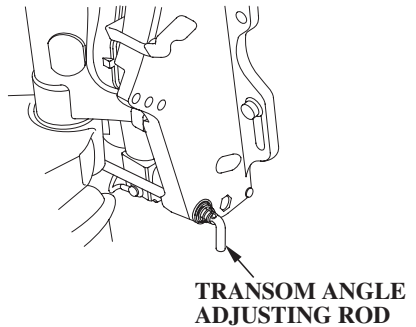

The transom angle adjusting rod limits the tilt angle of the outboard motor when fully lowered.

Proper adjustment prevents the outboard motor from being trimmed too low (p. 56).

Trim Tab

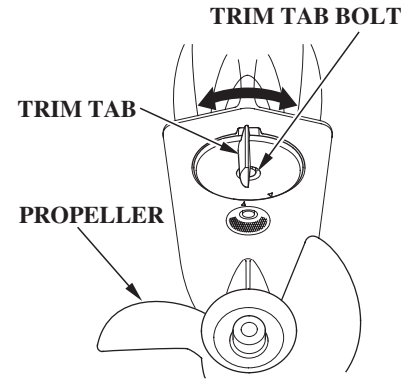

The trim tab compensates for “torque steer”, which is a reaction of the outboard motor to propeller rotation.

If uncompensated, torque steer would make the outboard motor tend to turn to one side.

When the trim tab is correctly adjusted (p. 69), steering effort is equal in either direction.

CONTROLS AND FEATURES

INSTRUMENTS

Trim Meter
[optional equipment (SRT and LRT Types)]

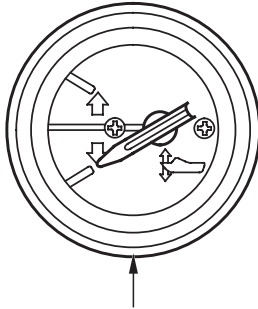

TRIM METER

The trim meter indicates the relative trim angle of the outboard motor.

Refer to the trim meter when using the power trim/tilt switch to achieve proper boat performance.

Tachometer
[optional equipment (SHG, LHT, SRG, LRG, SRT and LRT Types)]

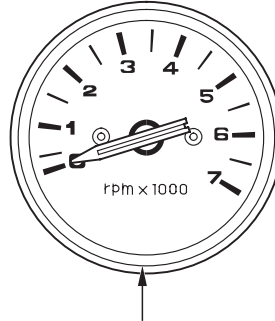

TACHOMETER

The tachometer shows engine speed in revolutions per minute.

Refer to the tachometer when using the throttle and power trim/tilt controls to achieve the best performance from the boat.

Fuel Gauge

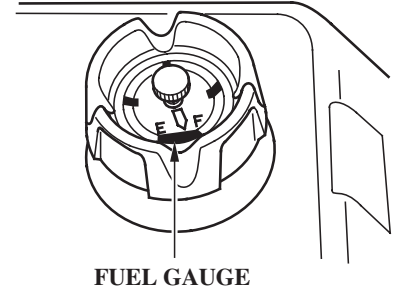

A fuel gauge is built into the cap of the portable fuel tank.

INDICATORS

Oil Pressure Indicator

SH and LH Types

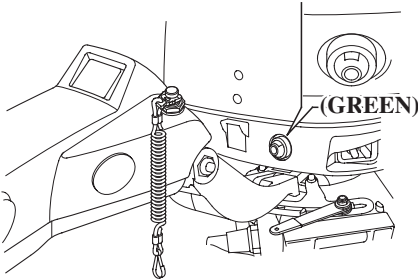

SHG and LHT Types

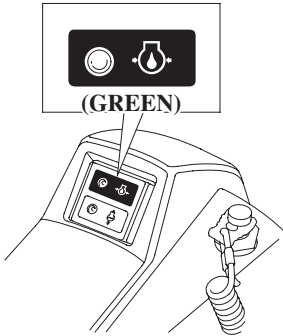

SRG, LRG, SRT and LRT Types (side-mount type)

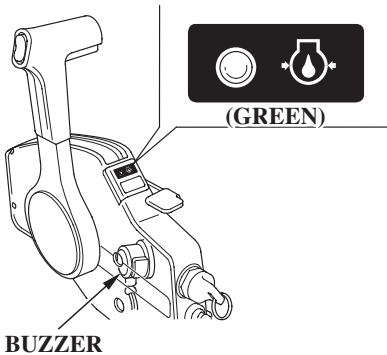

When the green light is lit, oil pressure is OK.

If oil pressure becomes low, the green light will go off, and the engine protection system will limit engine speed. Refer to *TAKING CARE OF UNEXPECTED PROBLEMS*, on p. 101.

Remote controls are also equipped with a buzzer that sounds continuously when the green light goes off. The buzzer sound stops below an engine speed of 1,400 rpm.

Low oil pressure indicates that the engine oil level is low, or that there is a problem with the engine lubrication system.

CONTROLS AND FEATURES

Overheat Indicator

SHG and LHT Types

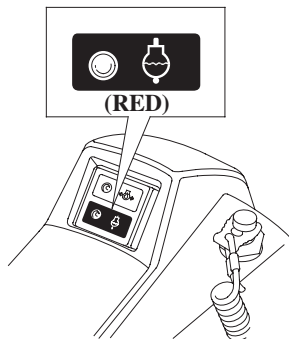

SRT and LRT Types (side-mount type)

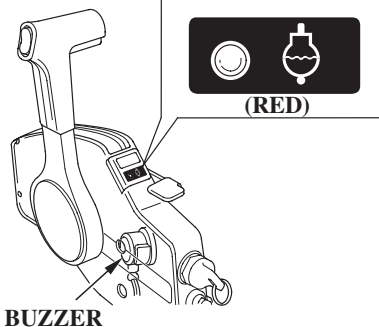

If the engine overheats, the red light will come on, and the engine protection system will limit engine speed. When normal engine temperature is restored, the engine speed will gradually rise to normal engine speed.

If the condition persists for another 20 seconds, the engine will shut off. Refer to *TAKING CARE OF UNEXPECTED PROBLEMS*, on p. 102.

Remote controls are also equipped with a buzzer that sounds when the red light comes on.

Engine overheating may be the result of clogged water intakes.

Cooling System Indicator

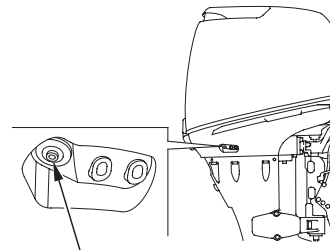

COOLING SYSTEM INDICATOR

Water should flow from the cooling system indicator while the engine is running. This shows that water is circulating through the cooling system.

If water stops flowing while the engine is running, that indicates a cooling system problem, such as clogged water intakes, which will cause engine overheating. Refer to *TAKING CARE OF UNEXPECTED PROBLEMS*, on p. 102 .

The cooling system indicator discharge port can also become plugged.

OTHER FEATURES

Anodes

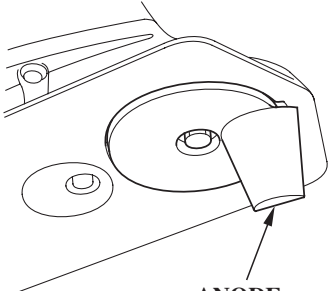

**ANODE
(trim tab)**

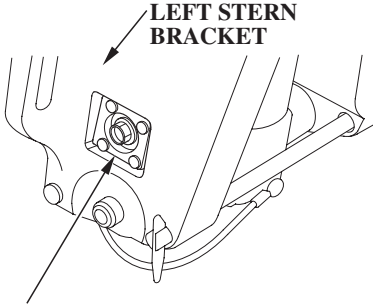

**ANODE
(SHG, LHT, SRG, LRG, SRT and
LRT types)**

The anodes are made of a sacrificial material that helps to protect the outboard motor from corrosion.

There are two anodes on the gear case, one on the stern bracket, and another is the trim tab.

CONTROLS AND FEATURES

Overrev Limiter

The engine is equipped with an overrev limiter to prevent the possibility of mechanical damage from excessive engine speed.

The overrev limiter may be activated during operation, limiting engine speed, if the outboard motor is tilted excessively, or when propeller ventilation occurs during a sharp turn.

If the overrev limiter is activated, check the trim angle of the outboard motor.

Portable Fuel Tank

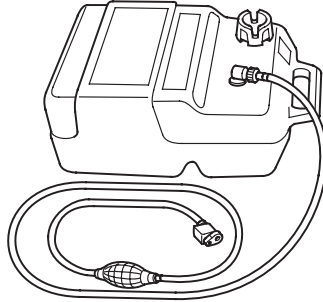

The portable fuel tank has a capacity of 6.6 US gal (25 l) and has a fuel gauge built into the cap.

Fuel Filler Cap Vent Knob

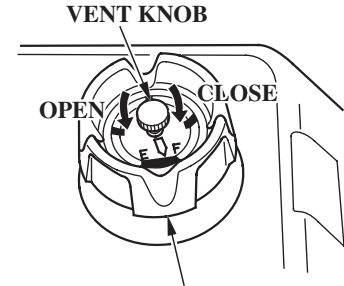

The cap is provided with a vent knob to seal the portable fuel tank for carrying it to and from the boat. Open the vent knob 2 or 3 turns before starting the engine.

Fuel Priming Bulb

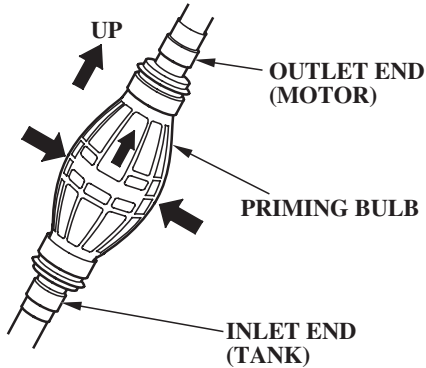

A priming bulb is built into the fuel hose that connects the fuel tank to the outboard motor.

Before starting the engine, hold the priming bulb up in the direction of the arrow, then squeeze the priming bulb until it feels firm. This will ensure that fuel is supplied to the engine.

INSTALLATION

Correct and secure installation is essential for safe boating and good performance. Follow the installation instructions provided in this manual.

POWER REQUIREMENTS

Before installation, check to be sure that the outboard motor does not exceed the recommended maximum horsepower for the boat on which it is to be installed. Refer to the boat's certification plate for recommended maximum horsepower. If the certification plate information is not available, contact the boat dealer or manufacturer.

For most applications, the outboard motor should have a horsepower rating which provides 80% of the maximum recommended horsepower for the boat.

BOAT TRANSOM REQUIREMENTS

Honda BF25D and BF30D outboard motors can be installed on a boat transom having a thickness range of 1.3 – 2.2 inches (35 – 57 mm).

INSTALLATION POSITION

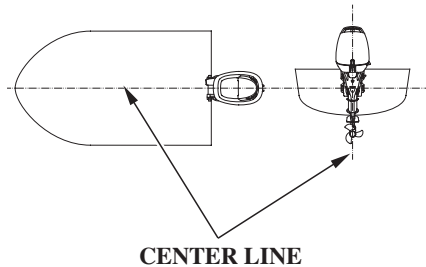

Install the outboard motor on the center of the boat transom.

The antiventilation plate of the outboard motor should be 0 – 2.0 in (0 – 50 mm) below the bottom of the boat.

The correct dimensions differ according to the type of the boat and the configuration of the bottom of the boats. Follow the manufacturer's recommended installation height.

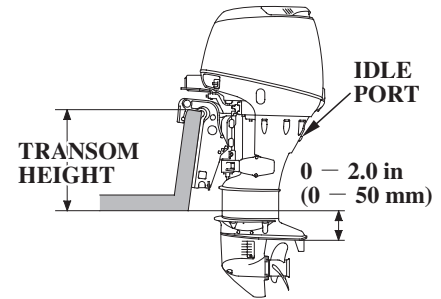

Type	Transom Height
S	17.0 in (431 mm)
L	21.7 in (552 mm)

When the outboard motor is installed extremely low, the idle port may be immersed and the engine may become hard to start or may run poorly. Check that the idle port is high enough from the water level when the engine is stopped with the boat fully loaded.

If the outboard motor is installed too high, that will cause propeller ventilation.

Optimum installation height varies with boat type and bottom shape. Contact the boat manufacturer for any special recommendations that are unique to a specific model of boat.

If the transom needs to be modified to accommodate the outboard motor, contact the boat manufacturer and follow their recommendations for corrective action.

ATTACHMENT (tiller handle type)

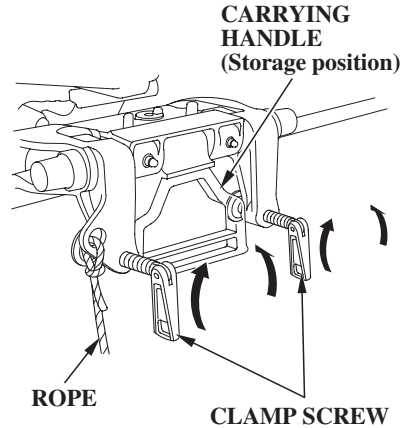

Attach the stern bracket to the boat transom by tightening the clamp screws. Push the carrying handle into the storage position. (tiller handle type)

Attach a rope from the boat to the hole in the stern bracket. This will help to prevent accidental loss of the outboard motor.

SH and LH types

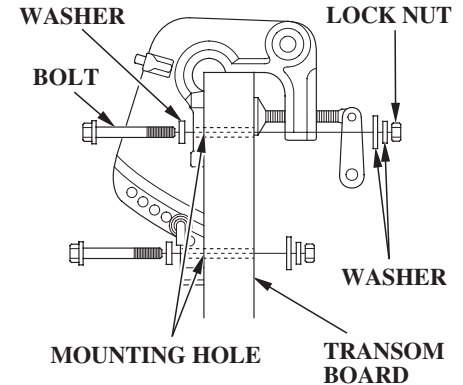

You may further secure the outboard motor by bolting the stern bracket to the boat transom. Use the optional mounting bolt and nut kit or other good quality stainless steel bolts, nuts, and washers. Apply silicone sealant to the bolt holes.

INSTALLATION

SHG, LHT, SRG, LRG, SRT and LRT types

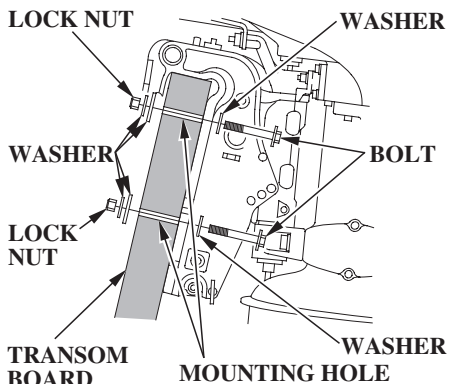

You may further secure the outboard motor by bolting the stern bracket to the boat transom. Use the mounting bolt and nut kit or other good quality stainless steel bolts, nuts, and washers. Apply silicone sealant to the bolt holes.

TRANSOM ANGLE ADJUSTMENT

Use the transom angle adjusting rod (p. 40) to adjust the angle of the outboard motor so the propeller is perpendicular to the surface of the water.

BATTERY CONNECTIONS

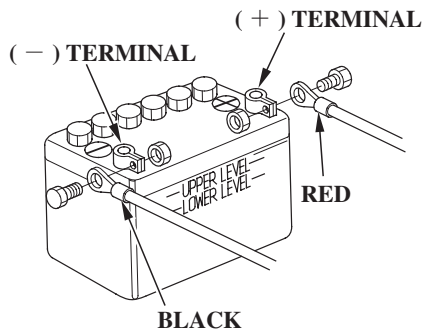

Honda BF25D and BF30D outboard motors produce a 12-volt, 4 or 10-ampere battery-charging current and are equipped for connection to a 12-volt battery. The battery-charging circuit is protected by a 15-ampere fuse located in the engine compartment.

The outboard motor's 12-volt output is designed to charge a "starting or cranking" battery only. It is not intended to charge a "deep-cycle" type battery. Lights and electrical accessories for the boat should be connected to the battery.

The battery should be kept in a corrosion-resistant battery box that is securely mounted in a location away from the fuel tank and protected from water and direct sunlight.

Types With Electric Starter

These types are equipped with battery cables. The positive (+) cable has a red band at the battery connector. The negative (-) cable has a black band at the battery connector.

For electric starter operation, use a 12-volt battery with an ampere-hour rating of at least 65 Ah (CCA 420).

Types With Recoil Starter

These types are equipped with a 12-volt DC battery-charging receptacle which can be wired to a 12-volt battery to power lights and electrical accessories for the boat.

Plug and Receptacle (types with recoil starter)

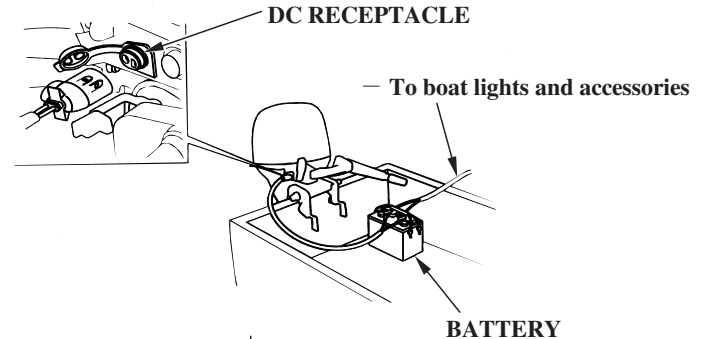

To prepare the outboard motor for connection to a battery, pull the cover off the DC receptacle, connect the battery charging wires to the plug. Attach the plug to the receptacle on the motor.

The receptacle is provided with a cover, which should be attached when the plug is removed, in order to keep the receptacle clean and dry.

Battery

For complete information, refer to the battery manufacturer's instructions.

Minimum Requirements

12V-65Ah (CCA 420)

INSTALLATION

Battery Terminals

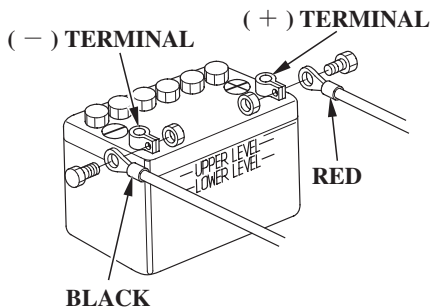

Connect the positive (+) battery cable to the positive (+) battery terminal, then connect the negative (-) battery cable to the negative (-) battery terminal.

The negative (-) battery cable should always be removed from the battery before connecting or disconnecting the positive (+) battery cable, so tools cannot cause a short circuit if they touch a grounded part while being used on the positive (+) battery terminal fitting.

NOTICE

Be careful to avoid connecting the battery in reverse polarity, as that will damage the battery-charging system in the outboard motor.

ARE YOU READY TO GET UNDER WAY?

Your safety is your responsibility. A little time spent in preparation will significantly reduce your risk of injury.

Knowledge

Read and understand this manual. Know what the controls do and how to operate them.

Familiarize yourself with the outboard motor and its operation before you get under way. Know what to do in case of emergencies.

Familiarize yourself with all laws and regulations relating to boating and the use of outboard motors.

Safety

Always wear a PFD (Personal Flotation Device) while on the boat.

Attach the emergency stop switch lanyard securely to your PFD or to your wrist.

IS YOUR OUTBOARD MOTOR READY TO GO?

For your safety, and to maximize the service life of your equipment, it is very important to take a few moments before you operate the outboard motor to check its condition. Be sure to take care of any problem you find, or have your authorized Honda marine dealer correct it, before you operate the outboard motor.

BEFORE OPERATION

WARNING

Improperly maintaining this outboard motor, or failing to correct a problem before operation, can cause a malfunction in which you could be seriously hurt or killed.

Always perform a preoperation inspection before each operation, and correct any problem.

Before beginning your preoperation checks, be sure the ignition switch is in the OFF position.

BEFORE OPERATION

Safety Inspection

- Look around the outboard motor for signs of oil or gasoline leaks.
- If you are using the portable fuel tank, make sure it is in good condition and properly secured in the boat (p. 42).
- Check that the fuel hose is undamaged and properly connected (p. 42).
- Wipe up any spills before starting the engine.
- Check the stern bracket to be sure the outboard motor is securely installed.
- Check that all controls are operating properly.
- Replace any damaged parts.

- Check that all fasteners are in place and securely tightened.

Maintenance Inspection

- Check the engine oil level (p. 71). Running the engine with a low oil level can cause engine damage.
- Check to be sure the propeller is undamaged, and the castle nut is secured with the cotter pin (p. 84).
- Check that the anodes are securely attached to the gear case (p. 82) and are not excessively worn. The anodes help to protect the outboard motor from corrosion.
- Make sure the tool kit and emergency starter rope are onboard (p. 66). Replace any missing items.
- Check the fuel level in the fuel tank (p. 77).
- Check that the battery fluid is between the upper and lower levels, and the battery leads are connected securely (electric starter type).

SAFE OPERATING PRECAUTIONS

To safely realize the full potential of this outboard motor, you need a complete understanding of its operation and a certain amount of practice with its controls.

Before operating the outboard motor for the first time, please review the *IMPORTANT SAFETY INFORMATION* on page 7 and the chapter titled *BEFORE OPERATION*.

For your safety, avoid starting or operating the engine in an enclosed area. Your engine's exhaust contains poisonous carbon monoxide gas which can collect rapidly in an enclosed area and cause illness or death.

BREAK-IN PROCEDURE

Break-in period: 10 hours

Proper break-in operation allows the moving parts to wear in smoothly for best performance and long service life.

First 15 minutes:

Run the engine at trolling speed. Use the minimum throttle opening necessary to operate the boat at a safe trolling speed.

Next 45 minutes:

Run the engine up to a maximum of 2,000 to 3,000 rpm, which is about 10% to 30% of maximum throttle opening.

Next 60 minutes:

Run the engine up to a maximum of 4,000 to 5,000 rpm, which is about 50% to 80% of maximum throttle opening.

Short full-throttle bursts are OK, but do not operate the engine continuously at full throttle.

For boats that plane easily, bring the boat up on plane, and then reduce the throttle opening to the recommended rpm range.

Next 8 hours:

Do not run the engine at full throttle for more than 5 minutes at a time.

OPERATION

TRANSOM ANGLE ADJUSTMENT

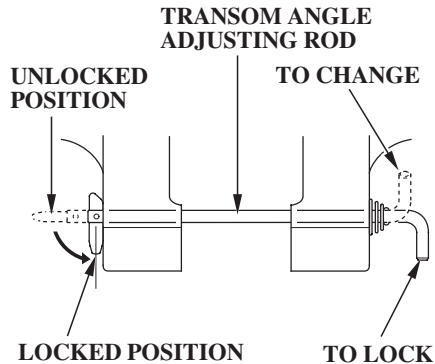
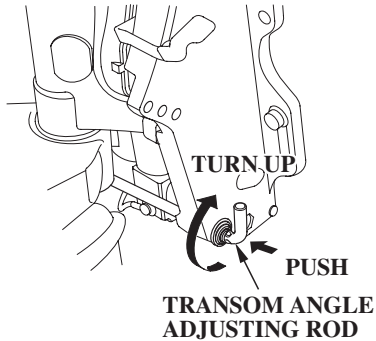

The transom angle adjusting rod limits the tilt angle of the outboard motor when fully lowered.

Proper adjustment prevents the outboard motor from being trimmed too low (p. 56).

To adjust, first tilt the outboard motor so it is not resting on the rod.

Push the rod in and turn the end of the rod up, so the latch will fall into line with the rod.

Remove the rod and reinsert it in the desired position.

Push the rod in and turn the end of the rod down, so the latch will fall to the locked position. Then release the rod.

NOTICE

Do not allow water to enter the idle exhaust port or the engine can be damaged.

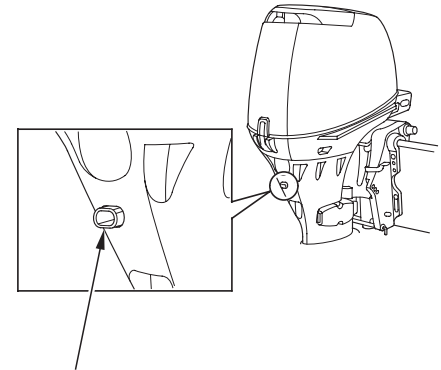

IDLE EXHAUST PORT

Motor Angle Inspection (Cruising)

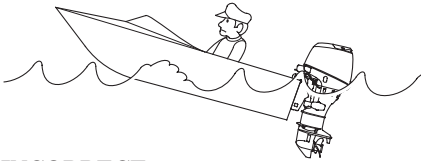

**INCORRECT
CAUSES BOAT TO "SQUAT"**

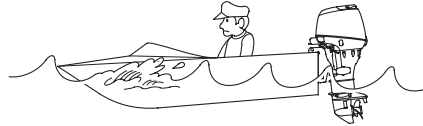

**INCORRECT
CAUSES BOAT TO "BOW STEER"**

O. K

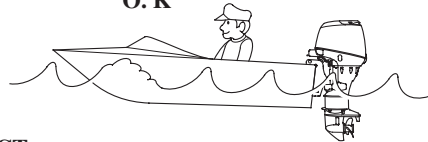

**CORRECT
GIVES MAXIMUM PERFORMANCE**

Install the outboard motor at the best trim angle for stable cruising and maximum power.

Trim angle too large: Incorrect causes boat to "squat".

Trim angle too small: Incorrect causes boat to "bow steer".

The trim angle differs according to the combination of the boat, outboard motor, and propeller, and the operating condition.

OPERATION

PORTABLE FUEL TANK

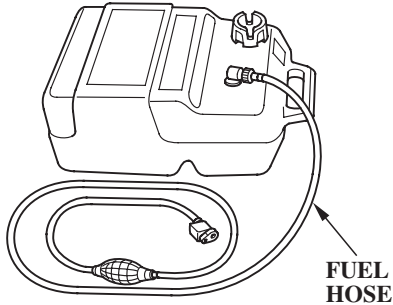

Place the portable fuel tank in a well-ventilated location, away from direct sunlight, to reduce the possibility of a gasoline vapor explosion.

To ensure that the outboard motor will be able to draw fuel from the tank, place the tank within 6 feet of the outboard motor and not more than 3 feet below the fuel connector on the outboard motor.

Secure the portable fuel tank in the boat, so it won't move around and become damaged.

Before use, open the fuel tank vent by turning the vent knob at least 2 or 3 turns counterclockwise.

⚠ WARNING

Gasoline is highly flammable and explosive.

You can be burned or seriously injured when handling fuel.

- Stop the engine and keep heat, sparks, and flame away.
- Handle fuel only outdoors.
- Wipe up spills immediately.

FUEL HOSE CONNECTIONS

FUEL HOSE CONNECTOR

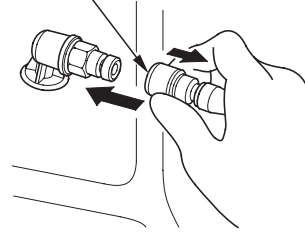

(FUEL TANK SIDE)

FUEL HOSE CONNECTOR

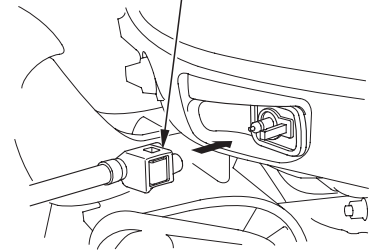

(OUTBOARD MOTOR SIDE)

Connect the fuel hose to the tank and the outboard motor, as shown. Be sure both connectors snap securely into place.

FUEL PRIMING

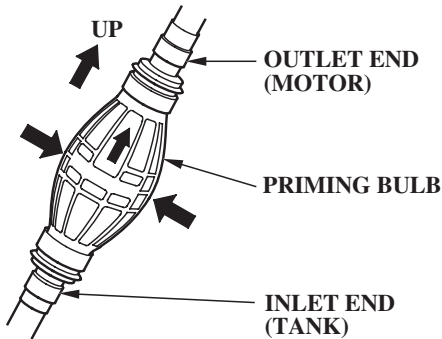

Hold the priming bulb with the outlet end higher than the inlet end. Squeeze the priming bulb several times, until it feels firm, indicating that fuel has reached the carburetor.

Check to be sure there are no fuel leaks before starting the engine.

Do not squeeze the priming bulb when the engine is running because that could flood the carburetor.

STARTING THE ENGINE

*SH, LH, SHG and LHT Types
(long tiller handle)*

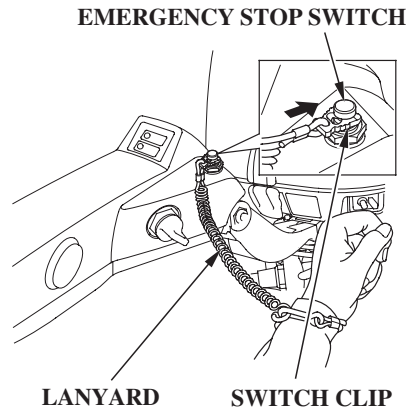

1. Put the emergency stop switch clip in the emergency stop switch, and attach the lanyard to your PFD (Personal Flotation Device) or to your wrist, as shown.

The engine will not start or run, unless the clip is in the switch.

The emergency stop switch clip and lanyard system is a safety device that will stop the engine if you fall away from the controls while operating the boat.

Always attach the lanyard to your PFD, or to your wrist, before starting the engine.

OPERATION

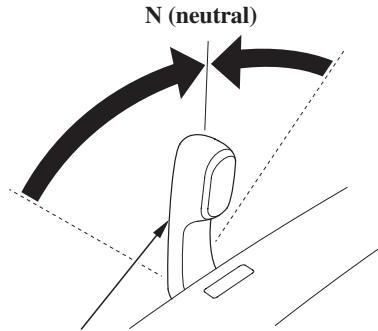

GEARSHIFT LEVER

2. Check the position of the gearshift lever. It must be in the N (neutral) position for starting.

The engine will not start if the gearshift lever is in the F (forward) or R (reverse) position.

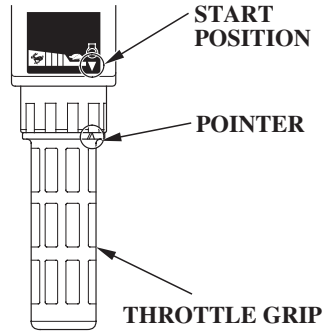

3. Align the engine start symbol "⊗" on the tiller handle with the pointer "▶" on the throttle grip.

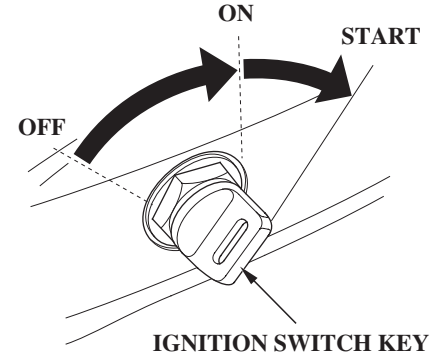
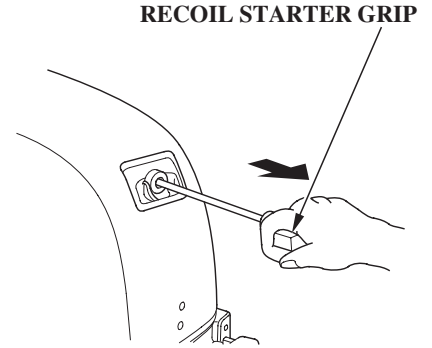

4. Recoil start type:

Pull the recoil starter grip slowly until you feel resistance, then pull briskly.

Return the starter grip gently.

Electric start type:

Turn the ignition switch key to the START position and hold it there until the engine starts.

When the engine starts, release the key, allowing it to return to the ON position.

If the engine fails to start within 5 seconds, release the key and wait at least 10 seconds before operating the starter again.

NOTICE

- *Using the electric starter for more than 5 seconds at a time will overheat the starter motor and can damage it.*
- *Turning the ignition switch key to the START position while the engine is running can damage the starter motor and flywheel.*

Also, as the engine warms up, the throttle grip can be turned to the SLOW position without stalling.

- #### 5. Before getting under way, allow the engine to warm up sufficiently to ensure good performance.

Above 41°F (5°C), warm up the engine for 2 or 3 minutes.

Below 41°F (5°C), warm up the engine for at least 10 minutes at 2,000 rpm.

During the warm-up period, check the oil pressure indicator (p. 27), overheat indicator (p. 28) and cooling system indicator (p. 28).

If the indicators show any abnormal condition, immediately stop the engine and determine the cause of the problem. Refer to **TAKING CARE OF UNEXPECTED PROBLEMS** from p. 101.

OPERATION

SRG, LRG, SRT and LRT Types (remote control)

For panel mount or top mount remote control information, refer to the instructions provided with the remote control equipment.

Side-Mount Type

EMERGENCY STOP SWITCH

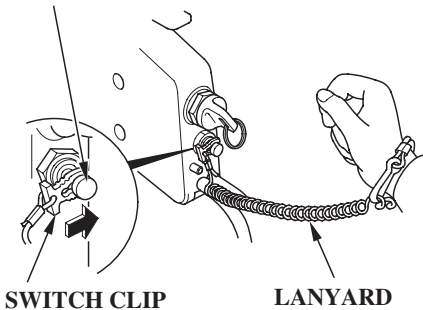

1. Put the emergency stop switch clip in the emergency stop switch, and attach the lanyard to your PFD (Personal Flotation Device) or to your wrist, as shown.

The engine will not start or run, unless the clip is in the switch.

The emergency stop switch clip and lanyard system is a safety device that will stop the engine if you fall away from the controls while operating the boat.

Always attach the lanyard to your PFD, or to your wrist, before starting the engine.

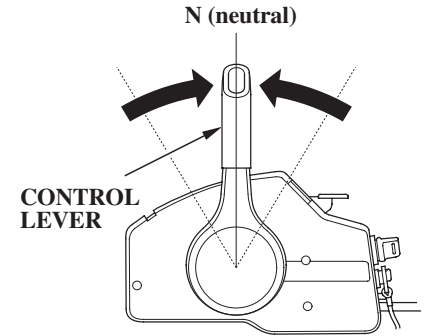

2. Set the control lever in the N (neutral) position.

The engine will not start if the F (forward) or R (reverse) gears are engaged.

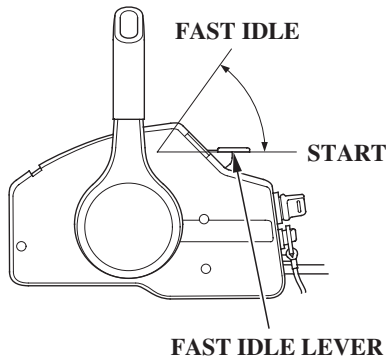

3. To start a cold engine, leave the fast idle lever in the START (fully lowered) position.

To restart a warm engine, raise the fast idle lever.

Fast idle lever cannot be raised unless the control lever is in the N (neutral) position.

The control lever cannot be moved away from the N (neutral) position unless the fast idle lever is lowered.

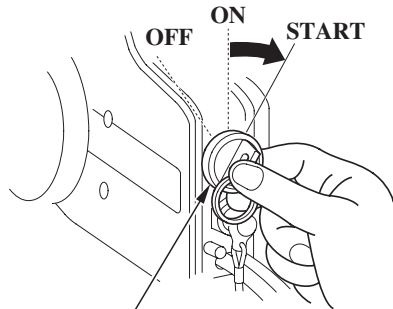

4. Turn the ignition switch key to the START position and hold it there until the engine starts.

When the engine starts, release the key, allowing it to return to the ON position.

If the engine fails to start within 5 seconds, release the key and wait at least 10 seconds before operating the starter again.

NOTICE

- Using the electric starter for more than 5 seconds at a time will overheat the starter motor and can damage it.
- Turning the ignition switch key to the START position while the engine is running can damage the starter motor and flywheel.

OPERATION

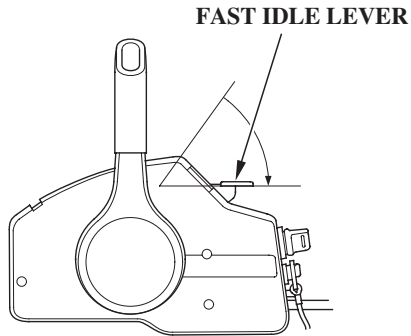

5. If the fast idle lever was used to start the engine, gradually lower the lever as the engine warms up.

When the fast idle lever is fully lowered, the control lever can be moved away from the N (neutral) position.

6. Before getting under way, allow the engine to warm up sufficiently to ensure good performance.

Above 41°F (5°C), warm up the engine for 2 or 3 minutes.

Below 41°F (5°C), warm up the engine for at least 10 minutes at 2,000 rpm.

During the warm-up period, check the oil pressure indicator (p. 27), overheat indicator (p. 28), and cooling system indicator (p. 28).

If the indicators show any abnormal condition, immediately stop the engine and determine the cause of the problem. Refer to *TAKING CARE OF UNEXPECTED PROBLEMS* from p. 101.

EMERGENCY STARTING

If the battery is discharged, or the starter motor is inoperative, you can start the engine manually using the emergency starter rope supplied with the motor.

(REAR)

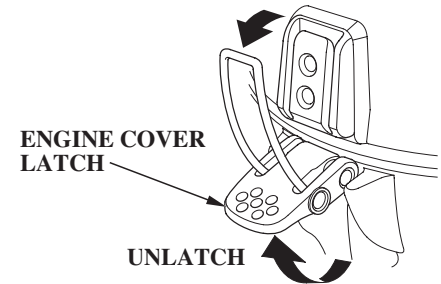

1. Unlatch and remove the engine cover.

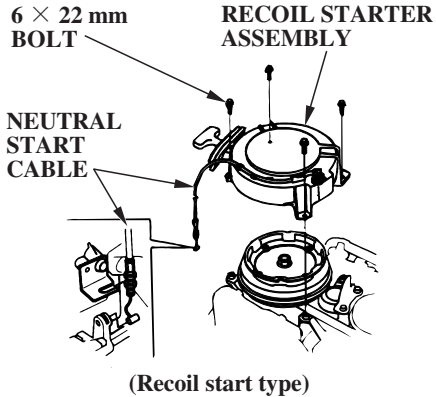

2. Recoil start type:
Loosen the neutral start cable lock nut and disconnect the neutral start cable.
Remove the recoil starter assembly by unscrewing the four starter assembly bolts.

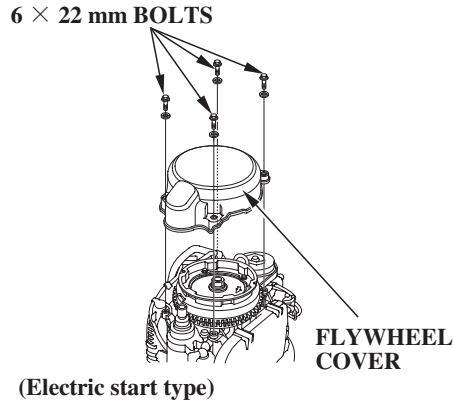

- Electric start type:
Remove the flywheel cover by unscrewing the four cover bolts.
3. Set the controls the same as for normal starting (see pages 43 — 47). Use the fast idle control if needed.

Electric start type:
Turn the ignition switch key to the ON position.

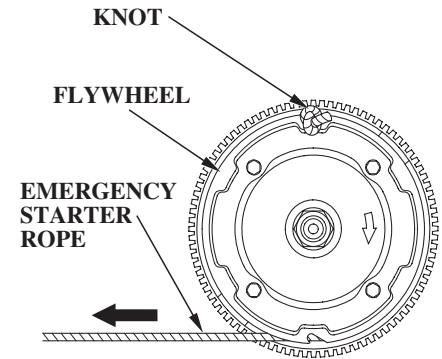

4. Set the knotted end of the emergency starter rope in the notch in the flywheel. Wind the rope clockwise around the flywheel, as shown.

OPERATION

EMERGENCY STARTER ROPE

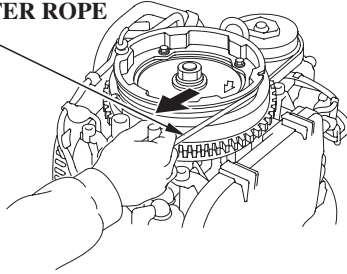

5. Pull the emergency starter rope slowly until resistance is felt, then pull briskly.

Keep away from moving parts while pulling the rope.

If necessary, rewind the rope and pull again. If the engine does not start after several attempts, refer to *TAKING CARE OF UNEXPECTED PROBLEMS* from p. 95 .

6. If the fast idle control(s) was used to start the engine, return the control(s) to the normal operating position as the engine warms up.

During the warm-up period, check the oil pressure indicator (p. 27), overheat indicator (p. 28), and cooling system indicator (p. 28).

7. Leave the recoil starter assembly off, but install the engine cover (p. 70), and lock it in place by latching the engine cover latch.

⚠ WARNING

Exposed moving parts can cause injury.

- Do not operate the outboard motor without the engine cover.
- Use extreme care when installing the engine cover.

8. If it was necessary to remove the emergency stop switch lanyard from your wrist to perform the emergency starting procedure, be sure the lanyard is attached to your wrist before operating the outboard motor.

9. Have your closest authorized Honda marine dealer check your electrical system and correct the problem, so you can use the electric starter.

STOPPING THE ENGINE

Emergency Engine Stopping

*SH, LH, SHG and LHT Types
(long tiller handle)*

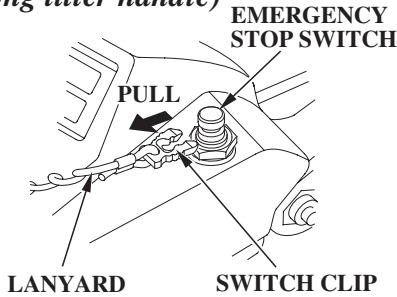

*SRG, LRG, SRT and LRT Types
(remote control)*

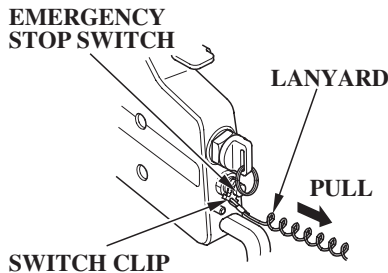

To stop the engine in an emergency, pull the clip out of the emergency stop switch by pulling the lanyard.

We suggest that you stop the engine this way occasionally to verify that the emergency stop switch is operating properly.

Turn the ignition switch key to the OFF position (electric start type) after verifying the emergency stop switch operation.

Normal Engine Stopping

*SH, LH, SHG and LHT Types
(long tiller handle)*

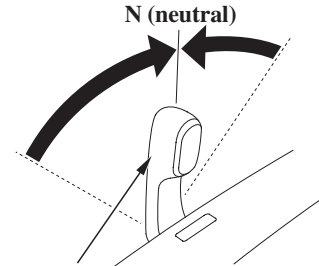
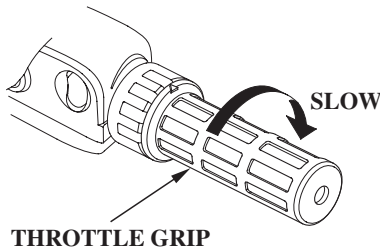

GEARSHIFT LEVER

*SRG, LRG, SRT and LRT Types
(remote control (side-mount type))*

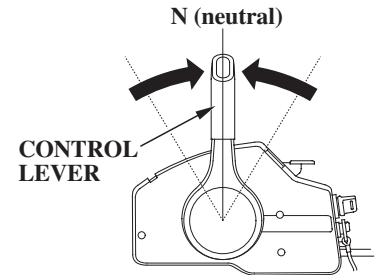

1. Move the throttle grip to the slowest speed and gearshift lever or control lever to N (neutral) position.

OPERATION

SH and LH Types (long tiller handle)

EMERGENCY STOP SWITCH

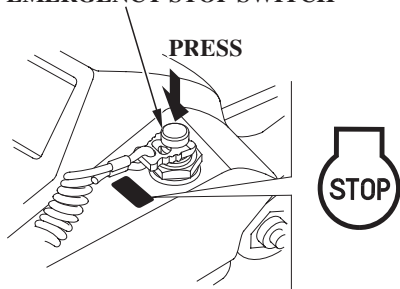

SHG and LHT Types (long tiller handle)

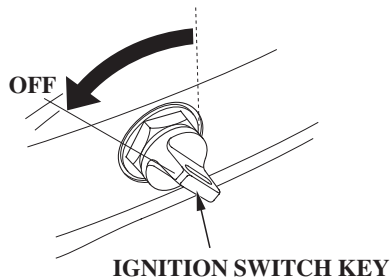

SRG, LRG, SRT and LRT Types (remote control)

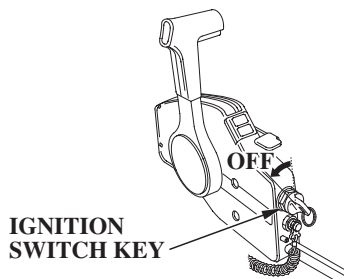

2. Turn the ignition switch key to the OFF position to stop the engine or press the emergency stop switch until the engine stops.
3. When the boat is not in use, remove and store the ignition key and the emergency stop switch clip and lanyard.

GEARSHIFTING AND THROTTLE OPERATION

SH, LH, SHG and LHT Types
(long tiller handle)

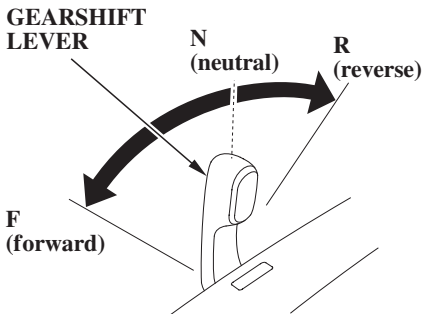
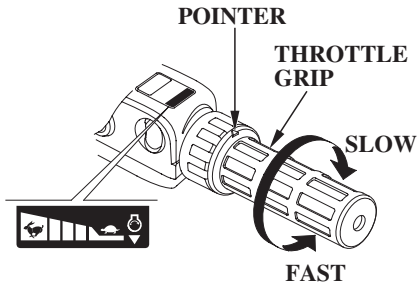

To shift gears, turn the throttle grip to the SLOW position, then move the gearshift lever to select F (forward), N (neutral) or R (reverse) gears.

The engine can be started with the gearshift lever in the N (neutral) position only.

The throttle grip can be turned to the FAST position only when the gearshift lever is in the F (forward) position.

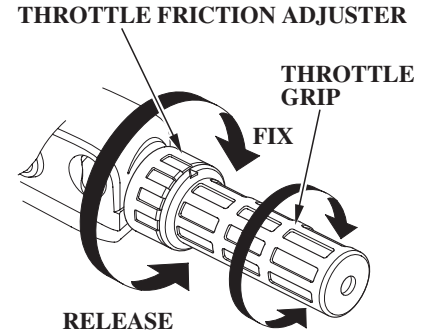

Use the throttle friction adjuster to help hold a constant throttle setting while cruising.

Turn the adjuster clockwise to increase throttle grip friction for holding a constant speed.

Turn the adjuster counterclockwise to decrease friction for easy grip rotation.

OPERATION

SRG, LRG, SRT and LRT Types (remote control)

Side-Mount Type

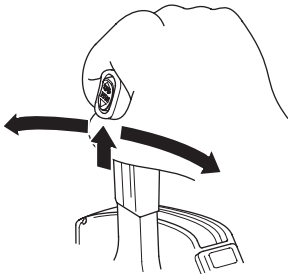
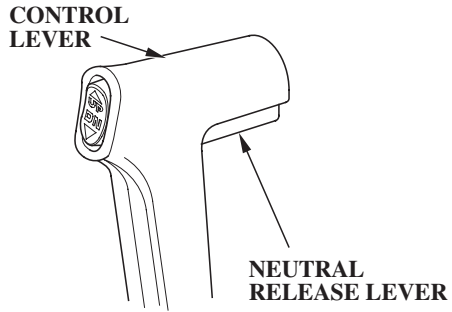

To shift gears, move the control lever to select F (forward), N (neutral) and R (reverse) gears.

The control lever cannot be moved from the N (neutral) position unless the neutral release lever is squeezed.

Moving the control lever beyond the gear selection range increases engine speed.

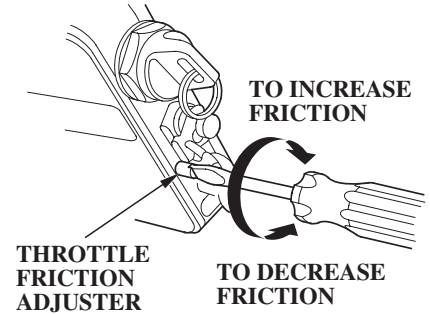

Adjust the throttle friction adjuster so the control lever will hold a constant throttle setting while cruising.

STEERING

SH, LH, SHG and LHT Types (long tiller handle)

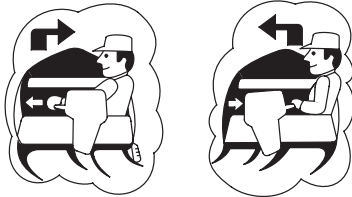

Steer by moving the tiller handle opposite the direction you want the boat to turn.

Steering Friction Adjuster

SH and LH Types

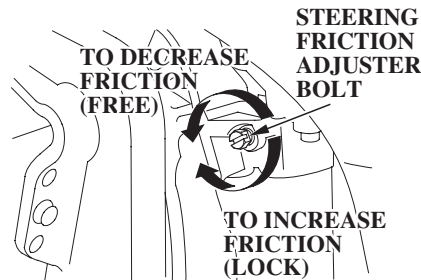

Use the steering friction adjuster to help hold a steady course while cruising.

Move the adjuster to the LOCK direction to increase steering friction for holding a steady course.

Move the adjuster to the FREE direction to decrease friction for easy turning.

NOTICE

Do not apply grease or oil on the friction plate. Grease or oil will reduce the friction of the adjuster.

SHG and LHT Types

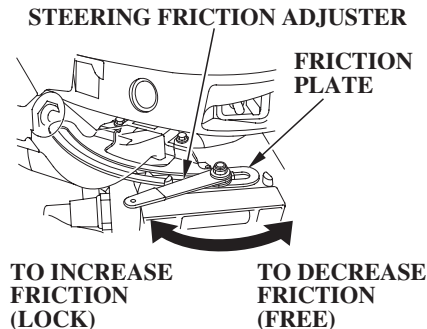

SRG, LRG, SRT and LRT Types (remote control)

Steer the boat in the same manner as an automobile.

OPERATION

CRUISING

Engine Speed

For best fuel economy, limit the throttle opening to 80%. Use the throttle friction control (p. 53 and 54) to help you hold a steady speed.

For rough water conditions or large waves, slow down to prevent the propeller from rising out of the water.

The engine is equipped with an overrev limiter to prevent the possibility of mechanical damage from excessive engine speed.

If, for example, the outboard motor is tilted excessively, or propeller ventilation occurs during a sharp turn, the engine may overrev, activating the overrev limiter.

If engine speed becomes unstable at high speed due to activation of the overrev limiter, reduce speed and check the trim angle of the outboard motor.

Trim

SH, LH, SHG, SRG and LRG Types

Install the outboard motor at the best trim angle for stable cruising and maximum power.

Trim angle too large: Incorrect causes boat to “squat”.

Trim angle too small: Incorrect causes boat to “bow steer”.

It is necessary to trim the angle of the outboard motor to compensate for changes in boat load, weight distribution, water conditions, or propeller selection.

Under normal conditions, the boat

will perform best when the antiventilation plate is level with the water surface.

When cruising into a high wind, trim the outboard motor down slightly to level the boat and improve stability. With a tail wind, trim the outboard motor up slightly.

LHT, SRT and LRT Types

Use the power trim/tilt switch to trim the outboard motor for the best performance and stability.

You can use the power trim/tilt switch at any time, whether the boat is under way or stopped.

Press the UP or DN (down) side of the switch to adjust the angle of the outboard motor.

Refer to the trim meter (p. 26) for an indication of whether the motor is trimmed high or low.

It is necessary to trim the angle of the outboard motor to compensate for changes in boat load, weight distribution, water conditions, or propeller selection.

Under normal conditions, the boat will perform best when the antiventilation plate is level with the water surface.

When cruising into a high wind, adjust the outboard motor down slightly to level the boat and improve stability. With a tail wind, adjust the outboard motor up slightly.

NOTICE

Excessive trim/tilt angle during operation can cause propeller ventilation, overheating, and water pump damage. This type of damage is not covered by the Distributor's Limited Warranty (p. 119).

LHT Type (long tiller handle)

POWER TRIM/TILT SWITCH

Press UP to trim or tilt the motor up.

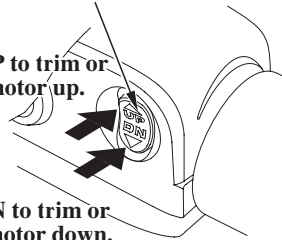

Press DN to trim or tilt the motor down.

SRT and LRT Types

POWER TRIM/TILT SWITCH

Press UP to trim or tilt the motor up.

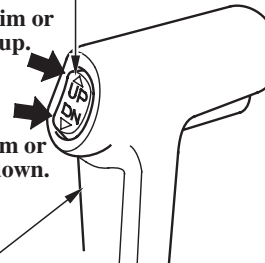

Press DN to trim or tilt the motor down.

CONTROL LEVER

MOTOR ANGLE
ADJUSTED TOO
LOW

MOTOR ANGLE
ADJUSTED TOO
HIGH

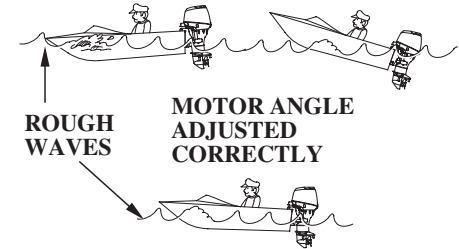

CORRECT
GIVES MAXIMUM PERFORMANCE

OPERATION

BOW TOO LOW DUE TO

1. LOAD IN THE FRONT
2. MOTOR ANGLE ADJUSTED TOO LOW

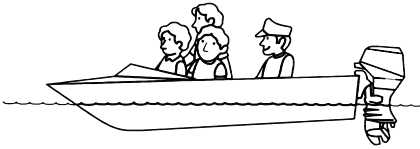

BOW TOO HIGH DUE TO

1. LOAD IN THE REAR
2. MOTOR ANGLE ADJUSTED TOO HIGH

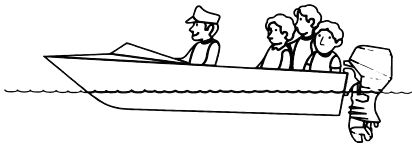

TRIM TAB

If steering effort is not equal in both directions, adjust the trim tab to compensate for “torque steer”, which is the reaction of the outboard motor to propeller rotation.

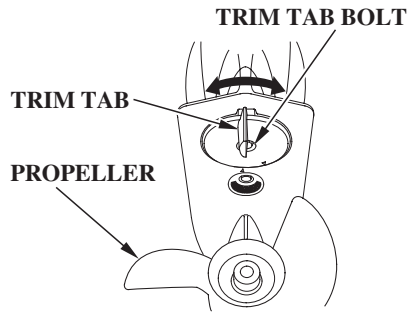

Adjust the trim tab with the engine stopped. Loosen the bolt above the trim tab, turn the trim tab, then tighten the bolt securely.

When the trim tab is correctly adjusted, steering effort will be equal in both directions.

SHALLOW WATER OPERATION

LHT, SRT and LRT Types

When operating in shallow water, use the power trim/tilt switch (p. 57) to tilt the outboard motor, so the propeller and gear case won't hit the bottom.

Proceed at low speed, and monitor water flow from the cooling system indicator (p. 28) to be sure the outboard motor is not tilted so high that the water intakes are out of the water.

NOTICE

An excessive trim/tilt angle during operation can cause propeller ventilation, overheating, and water pump damage. This type of damage is not covered by the Distributor's Limited Warranty (p. 119).

SHG, SRG and LRG Types

When operating in shallow water, tilt the outboard motor, using the tilt lever, so the propeller and gear case won't hit the bottom.

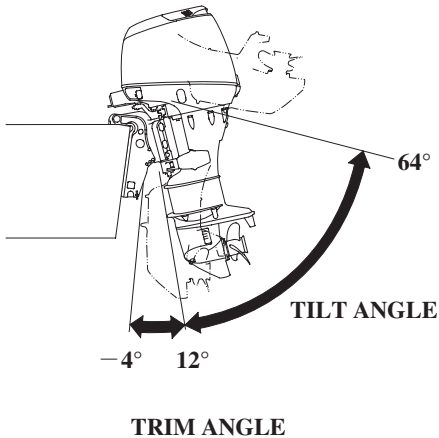

(transom angle at 12°)

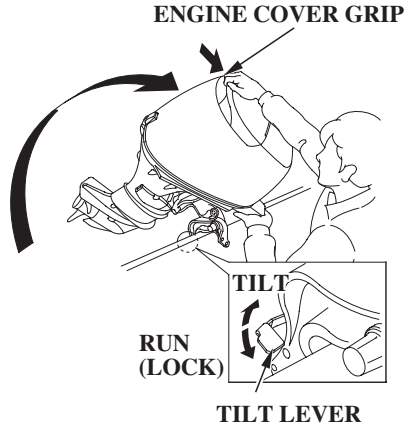

To tilt the outboard motor, move the tilt lever to the TILT position, then raise the outboard motor to the desired position by pulling on the engine cover grip.

NOTICE

Do not use the tiller handle as a lever to raise the outboard motor. Applying excessive force to the tiller handle can damage it.

While the outboard motor is tilted, proceed at a low speed, and do not operate the outboard motor in reverse. The outboard motor will rise suddenly if operated in reverse.

Monitor water flow from the cooling system indicator (p. 28) to be sure the outboard motor is not tilted so high the water intake is out of the water.

NOTICE

An excessive tilt angle during operation can cause propeller ventilation, overheating, and water pump damage. This type of damage is not covered by the Distributor's Limited Warranty (p. 119).

To return the outboard motor to the normal operating position, move the tilt lever to the RUN (LOCK) position, you may need to raise the outboard motor slightly to disengage the tilt mechanism, then slowly lower the outboard motor.

OPERATION

SH and LH Types

When operating in shallow water, tilt the outboard motor, using the tilt lever, so the propeller and gear case won't hit the bottom.

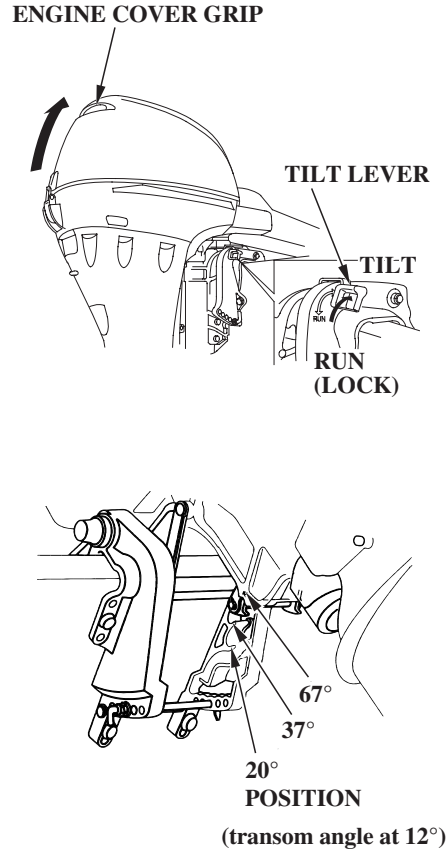
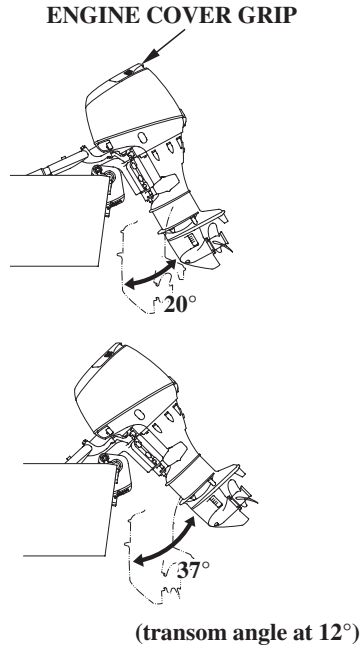

To tilt the outboard motor, move the tilt lever to the TILT position, then raise the outboard motor to the 20° or 37° position by pulling on the engine cover grip.

NOTICE

Do not use the tiller handle as a lever to raise the outboard motor. Applying excessive force to the tiller handle can damage it.

While the outboard motor is tilted, proceed at a low speed, and do not operate the outboard motor in reverse. The outboard motor will rise suddenly if operated in reverse.

Monitor water flow from the cooling system indicator (p. 28) to be sure the outboard motor is not tilted so high the water intake is out of the water.

NOTICE

An excessive tilt angle during operation can cause propeller ventilation, overheating, and water pump damage. This type of damage is not covered by the Distributor's Limited Warranty (p. 119).

MOORING, BEACHING, LAUNCHING

SH and LH Types

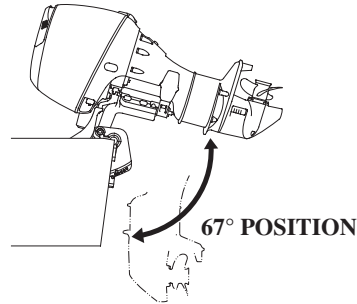

(transom angle at 12°)

To tilt the outboard motor, move the tilt lever to the TILT position, then raise the outboard motor to the 67° position by pulling on the engine cover grip as described on p. 60.

NOTICE

Do not use the tiller handle as a lever to raise the outboard motor. Applying excessive force to the tiller handle can damage it.

SHG, SRG and LRG Types

Use the tilt lever to raise and lower the outboard motor as described on p. 59.

LHT, SRT and LRT Types

To raise the outboard motor out of the water while the engine is stopped and the boat is moored, or for maximum clearance when beaching or launching, use the power tilt switch on the engine pan to tilt the outboard motor as far as it will go, move the tilt lock lever to the LOCK position, then gently lower the outboard motor until the lever contacts the stern bracket.

OPERATION

If more clearance is needed to swing the tilt lock lever into the LOCK position, rock the outboard motor forward slightly by pulling on the engine cover grip.

To lower the outboard motor, tilt up, move the tilt lock lever to the FREE position, then lower the outboard motor to the desired position.

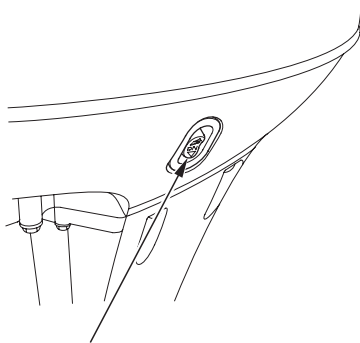

POWER TILT SWITCH

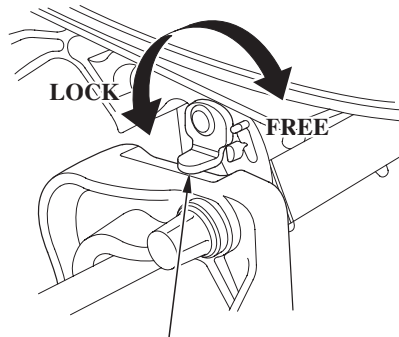

**TILT LOCK LEVER
(lock position)**

NOTICE

Do not attempt to use the power tilt switch to tilt the outboard motor down while the tilt lock lever is in the lock position. Damage to the power tilt system may occur.

RIGHT STERN BRACKET

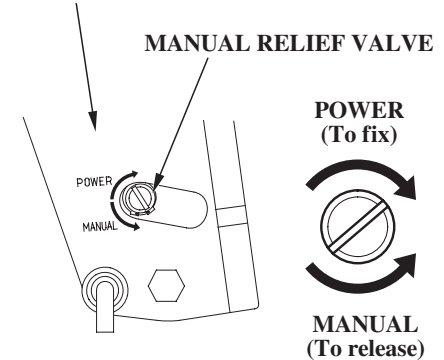

The outboard motor can also be tilted manually after opening the manual relief valve. This feature enables the outboard motor to be tilted when no battery is connected.

For manual tilting, use a flat blade screwdriver to turn the valve counterclockwise 2 and a half turns. Close the valve firmly after positioning the engine.

Be sure the valve is closed before operating the outboard motor. If the valve is not closed, the outboard motor will tilt up when operated in reverse.

SERVICING YOUR OUTBOARD MOTOR

THE IMPORTANCE OF MAINTENANCE

Good maintenance is essential for safe, economical, and trouble-free operation. It will also help reduce air pollution.

WARNING

Improperly maintaining this outboard motor, or failure to correct a problem before operation, can cause a malfunction in which you could be seriously hurt or killed.

Always follow the inspection and maintenance recommendations and schedules in this owner's manual.

To help you properly care for your outboard motor, the following pages include a maintenance schedule, routine inspection procedures, and simple maintenance procedures using basic hand tools. Other service tasks that are more difficult, or require special tools, are best handled by professionals and are normally performed by a Honda technician or other qualified mechanic.

The maintenance schedule applies to normal operating conditions. If you operate your outboard motor under unusual conditions, consult an authorized Honda marine dealer for recommendations applicable to your individual needs and use.

Remember that your authorized Honda marine dealer knows your outboard motor best and is fully equipped to maintain and repair it.

To ensure the best quality and reliability, use only new, genuine Honda parts or their equivalents for repair and replacement.

Maintenance, replacement, or repair of the emission control devices and systems may be performed by any marine engine repair establishment or individual, using parts that are “certified” to EPA standards.

SERVICING YOUR OUTBOARD MOTOR

MAINTENANCE SAFETY

Some of the most important safety precautions follow. However, we cannot warn you of every conceivable hazard that can arise in performing maintenance. Only you can decide whether or not you should perform a given task.

WARNING

Failure to properly follow maintenance instructions and precautions can cause you to be seriously hurt or killed.

Always follow the procedures and precautions in the owner's manual.

Safety Precautions

- Make sure the engine is off before you begin any maintenance or repairs. This will eliminate several potential hazards:
 - **Carbon monoxide poisoning from engine exhaust.**
Be sure there is adequate ventilation whenever you operate the engine.
 - **Burns from hot parts.**
Let the engine and exhaust system cool before touching.
 - **Injury from moving parts.**
Do not run the engine unless instructed to do so.
- Read the instructions before you begin, and make sure you have the tools and skills required.
- To reduce the possibility of fire or explosion, be careful when working around gasoline. Use only a nonflammable solvent, not gasoline, to clean parts. Keep cigarettes, sparks, and flames away from all fuel-related parts.
- Wear gloves when handling the propeller to protect your hands from sharp edges.

SERVICING YOUR OUTBOARD MOTOR

SPARE EMERGENCY STOP SWITCH CLIP (long tiller handle type) AND EMERGENCY STARTER ROPE



SPARE EMERGENCY STOP SWITCH CLIP (long tiller handle type)

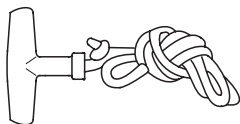

EMERGENCY STARTER ROPE

Always carry the spare emergency stop switch clip and the emergency starter rope onboard. The spare clip may either be stored in the tool bag or in an easily accessible location on the boat along with the emergency starter rope.

TOOL KIT

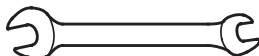

10 × 12 mm WRENCH



OIL CHECK SCREWDRIVER



FLAT SCREWDRIVER



PHILLIPS SCREWDRIVER



SCREWDRIVER HANDLE



PLIERS



18 × 19 mm SOCKET WRENCH



8 mm WRENCH

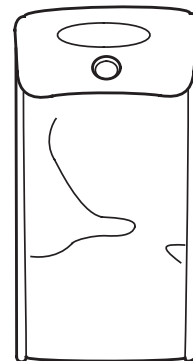

TOOL BAG

Individual items in the tool kit shown above can be purchased from an authorized Honda marine dealer and may be used for simple maintenance procedures and/or emergency repairs. Keep this tool kit or an equivalent onboard, so they will always be available if you need them.

If your tool kit needs replacement, it is not available as a kit and each item must be ordered individually.

SERVICING YOUR OUTBOARD MOTOR

MAINTENANCE SCHEDULE

Follow the MAINTENANCE SCHEDULE table and service your outboard motor accordingly. Please note, a claim for warranty coverage will not be denied simply because the maintenance schedule for your outboard was not followed. However, any part(s) that fails specifically due to lack of maintenance, or improperly performed maintenance, would not be covered under the *Distributor's Limited Warranty*.

REGULAR SERVICE PERIOD (3) Perform at every indicated month or operating hour interval, whichever comes first.		Each use	After use	First month or 20 hrs.	Every 6 months or 100 hrs.	Every year or 200 hrs.	Every 2 years or 400 hrs.
ITEM							
Engine oil	Check level	○					
	Change			○	○		
Gear case oil	Change			○ (2)	○ (2)		
Engine oil filter	Replace					○ (2)	
Timing belt	Check-adjust					○ (2)	
Starter rope	Check				○		
Carburetor linkage	Check-adjust			○ (2)	○ (2)		
Idle speed	Check-adjust			○ (2)	○ (2)		
Valve clearance	Check-adjust					○ (2)	
Spark plug	Check-adjust				○		
	Replace					○	
Propeller and Cotter pin	Check	○					
Anode	Check	○					
Lubrication	Grease			○ (1)	○ (1)		

- (1) Lubricate more frequently when used in salt water.
- (2) These items should be serviced by an authorized Honda marine dealer, unless you have the proper tools and are mechanically proficient. Refer to the Honda shop manual for service procedures.
- (3) For professional commercial use, log hours of operation to determine proper maintenance intervals.

SERVICING YOUR OUTBOARD MOTOR

REGULAR SERVICE PERIOD (3) Perform at every indicated month or operating hour interval, whichever comes first.		Each use	After use	First month or 20 hrs.	Every 6 months or 100 hrs.	Every year or 200 hrs.	Every 2 years or 400 hrs.	
ITEM								
Thermostat	Check					○ (2)		
Fuel filter	Check				○			
	Replace						○	
Fuel line	Check	○						
	Replace		Every 2 years (If necessary) (2)					
Battery and cable connection	Check level-tightness	○						
Bolts and nuts	Check-tightness			○ (2)	○ (2)			
Crankcase breather tube	Check					○ (2)		
Cooling water passages	Clean		○ (4)					
Water pump	Check					○ (2)		

- (1) Lubricate more frequently when used in salt water.
- (2) These items should be serviced by an authorized Honda marine dealer, unless you have the proper tools and are mechanically proficient. Refer to the Honda shop manual for service procedures.
- (3) For professional/commercial use, log hours of operation to determine proper maintenance intervals.
- (4) When operating in salt water, turbid or muddy water, the engine should be flushed with clean water after each use.

SERVICING YOUR OUTBOARD MOTOR

TRIM TAB ADJUSTMENT

The trim tab compensates for “torque steer” which is a reaction of the outboard motor to propeller rotation.

If uncompensated, torque steer would make the outboard motor tend to turn to one side.

When the trim tab is correctly adjusted, steering effort is equal in either direction.

If steering effort is unequal, loosen the trim tab bolt and adjust the angle of the trim tab. Retighten the trim tab bolt securely.

If less effort is required to make left turns, move the back of the trim tab left.

If less effort is required to make right turns, move the back of the trim tab right.

Adjust the trim tab in small increments, and retest steering effort with the boat evenly loaded and running at cruising speed.

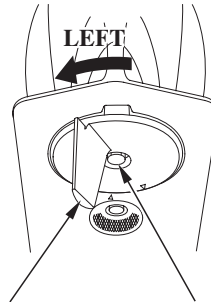
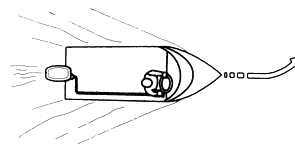

TRIM TAB TRIM TAB BOLT

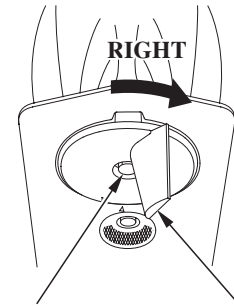
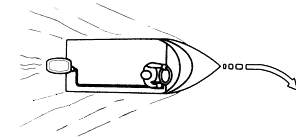

TRIM TAB BOLT TRIM TAB

SERVICING YOUR OUTBOARD MOTOR

MANUAL RELIEF VALVE

LHT, SRT and LRT Types

RIGHT STERN BRACKET

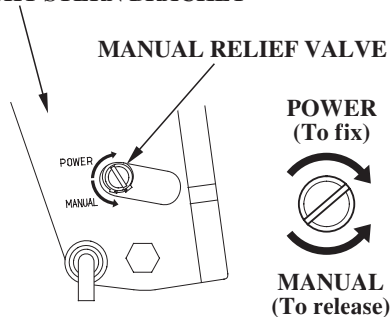

The outboard motor can be tilted manually after opening the manual relief valve. This feature enables the outboard motor to be tilted when no battery is connected.

For manual tilting, use a flat blade screwdriver to turn the valve counterclockwise 2 and a half turns. Close the valve firmly after positioning the engine.

Be sure the valve is closed before operating the outboard motor. If the valve is not closed, the outboard motor will tilt up when operated in reverse.

ENGINE COVER REMOVAL AND INSTALLATION

(REAR)

ENGINE COVER LATCH

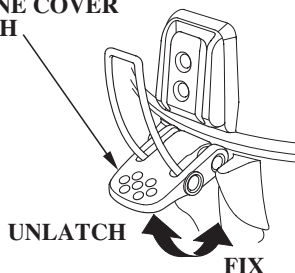

(FRONT)

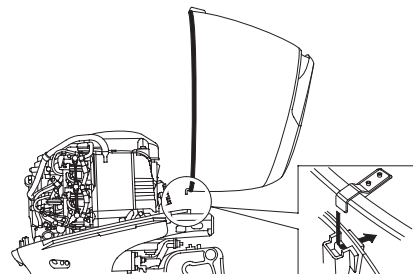

The engine cover latch fastens the engine cover to the outboard motor.

To remove the engine cover, unlatch the engine cover latch, then lift the engine cover off the outboard motor.

To install the engine cover, place the cover on the outboard motor, then latch the engine cover latch securely.

SERVICING YOUR OUTBOARD MOTOR

Engine Oil Level Check

Check the engine oil level with the engine stopped and the outboard motor in the vertical position.

1. Unlatch and remove the engine cover (p. 70).
2. Remove the dipstick and wipe it clean.

OIL LEVEL DIPSTICK

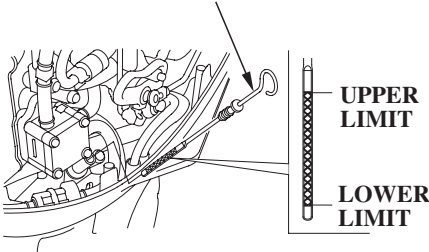

3. Insert the dipstick all the way in, then remove it and check the oil level shown on the dipstick.

OIL FILLER CAP

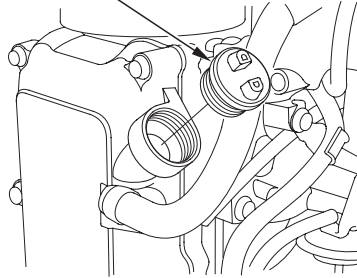

4. If the oil level is low, remove the oil filler cap, and add oil to reach the upper limit mark shown on the dipstick. Use the oil recommended on p. 73 .

NOTICE

Running the engine with a low oil level can cause engine damage.

5. Install the oil filler cap and tighten it securely.
6. Install and lock the engine cover.

SERVICING YOUR OUTBOARD MOTOR

Engine Oil Change

An engine oil evacuation device may be used to remove the engine oil.

Drain the used oil while the engine is warm. Warm oil drains quickly and completely.

1. Unlatch and remove the engine cover (p. 70). Remove the oil filler cap.

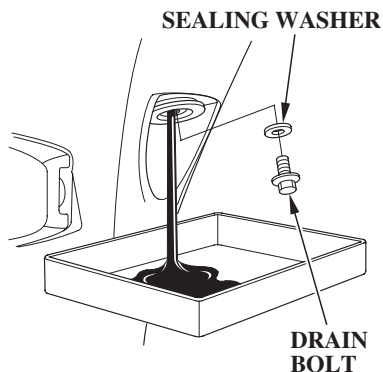

2. Place a suitable container below the drain bolt hole to catch the used oil, then remove the engine oil drain bolt and washer.
3. Allow the used oil to drain completely, then install a new sealing washer on the engine oil drain bolt, and tighten it securely.

NOTICE

Improper disposal of engine oil can be harmful to the environment. If you change your own oil, please dispose of the used oil properly. Put it in a sealed container, and take it to a recycling center. Do not discard it in a trash bin, dump it on the ground or pour it down a drain.

SERVICING YOUR OUTBOARD MOTOR

4. With the outboard motor in a vertical position, fill to the upper limit mark on the dipstick (p. 71) with the recommended oil.

Engine oil refill capacity:

Without oil filter change:

1.7 US qt (1.6 ℓ)

With oil filter change:

2.0 US qt (1.9 ℓ)

5. Install the oil filler cap and tighten it securely.
6. Install and lock the engine cover.

Engine Oil Recommendations

Oil is a major factor affecting performance and service life. Use 4-stroke automotive detergent oil.

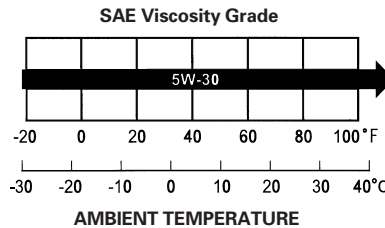

SAE 5W-30 is recommended for general use.

The SAE oil viscosity and service classification are in the API label on the oil container. Honda recommends that you use API SERVICE category SG, SH, SJ or SL oil with the “starburst” certification mark displayed on the container.

SERVICING YOUR OUTBOARD MOTOR

Lubrication Points

Apply marine anticorrosion grease to the following parts:

Lubrication interval:

After the first 20 hours or 1 month, then every 100 hours or 6 months. (Refer to the maintenance schedule page 67).

NOTICE

To prevent corrosion, apply anticorrosion oil to pivot surfaces where grease cannot penetrate.

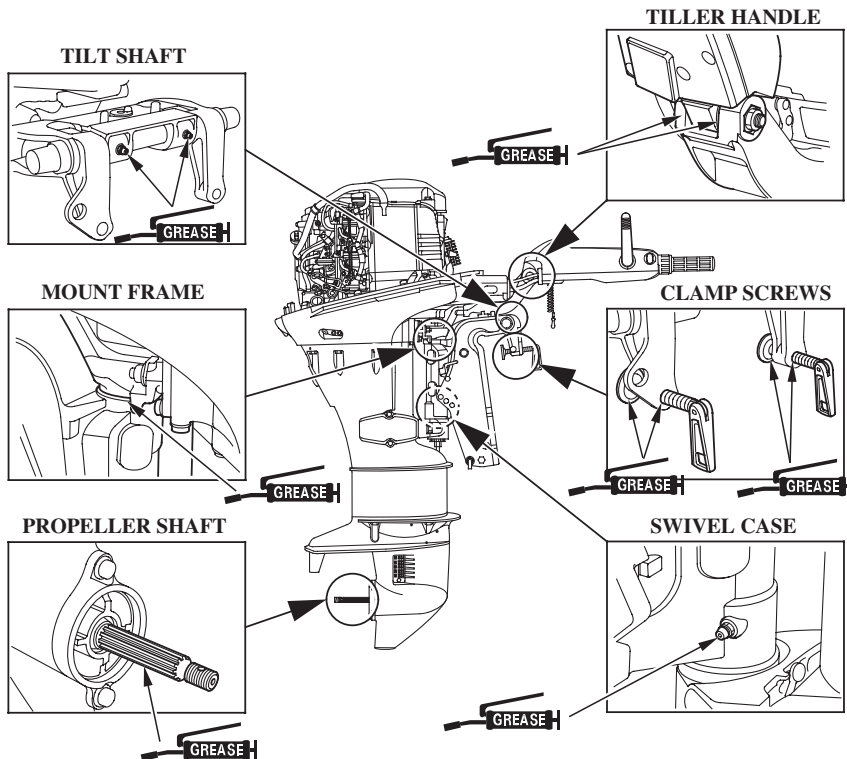

Apply Honda Marine Corrosion Inhibitor (or equivalent) to all areas under the engine cover and any exposed metal surfaces except the belts.

SERVICING YOUR OUTBOARD MOTOR

Spark Plug Service

RECOMMENDED SPARK PLUGS:
DR7EA (NGK)
X22ESR-U (DENSO)

NOTICE

Incorrect spark plugs can cause engine damage.

1. Unlatch and remove the engine cover (p. 70).
2. Disconnect the spark plug caps from the spark plugs.
3. Remove the spark plugs with a spark plug wrench.

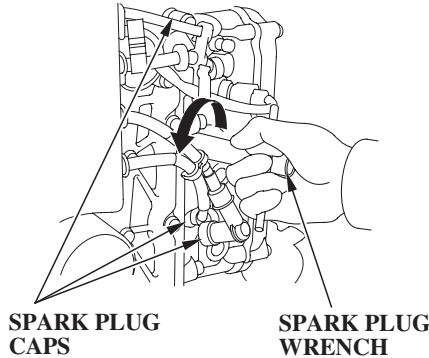

4. Inspect the spark plugs. Replace them if the electrodes are worn, or if the insulators are cracked or chipped.

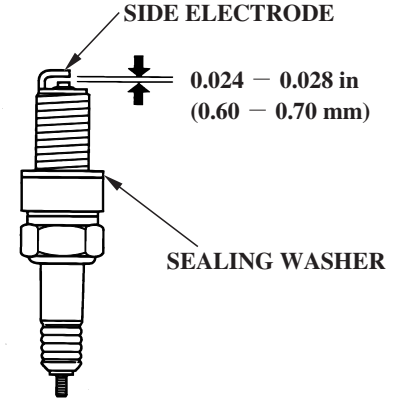

5. Measure the spark plug electrode gap with a wire-type feeler gauge. Correct the gap, if necessary, by carefully bending the side electrode.

The gap should be:
0.024 - 0.028 in
(0.60 - 0.70 mm)

SERVICING YOUR OUTBOARD MOTOR

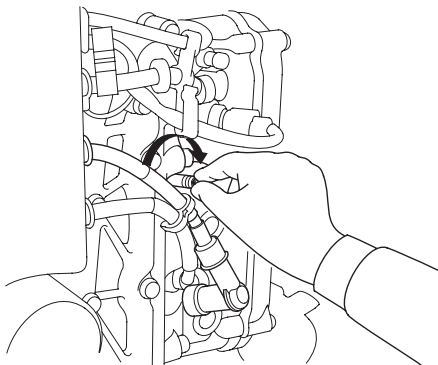

6. Install the spark plugs carefully, by hand, to avoid cross-threading.

7. After each spark plug seats, tighten with a spark plug wrench to compress the sealing washer.

If reinstalling used spark plugs, tighten 1/8 – 1/4 turn after the spark plugs seat.

If installing new spark plugs, tighten 1/2 turn after the spark plugs seat.

NOTICE

Loose spark plugs can overheat and damage the engine.

Overtightening the spark plugs can damage the threads in the cylinder head.

8. Attach the spark plug caps.

9. Install and lock the engine cover.

SERVICING YOUR OUTBOARD MOTOR

REFUELING

Portable Fuel Tank

FUEL TANK CAPACITY:
6.6 US gal (25 ℓ)

Check the fuel gauge and refill the tank when necessary.

Remove the fuel tank from the boat for refueling.

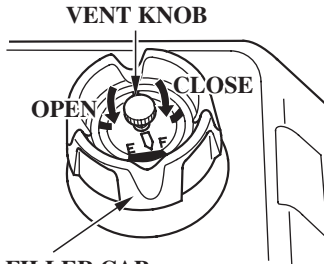

FUEL FILLER CAP

To refuel, turn the vent knob counterclockwise to the OPEN position, and unscrew the fuel filler cap.

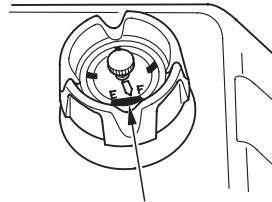

FUEL GAUGE

SAFE FILL LEVEL

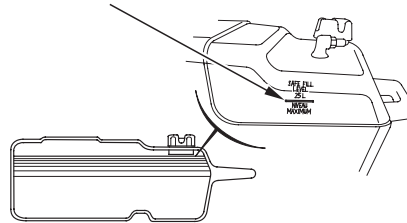

Refuel in a well-ventilated area. Fill the tank to the SAFE FILL LEVEL line.

After refueling, install the cap and tighten it securely. Turn the vent knob clockwise to the CLOSED position, and return the fuel tank to the boat.

⚠ WARNING

Gasoline is highly flammable and explosive.

You can be burned or seriously injured when handling fuel.

- Stop the engine and keep heat, sparks, and flame away.
- Handle fuel only outdoors.
- Wipe up spills immediately.

Never refill the fuel tank inside a building where gasoline fumes may reach flames or sparks. Keep gasoline away from appliance pilot lights, barbecues, electric appliances, power tools, etc.

Spilled fuel is not only a fire hazard, it causes environmental damage. Wipe up spills immediately.

SERVICING YOUR OUTBOARD MOTOR

FUEL RECOMMENDATIONS

Use unleaded gasoline with a pump octane rating of 86 or higher.

Your outboard motor is certified to operate on unleaded gasoline. Unleaded gasoline produces fewer engine and spark plug deposits and extends exhaust system life.

Never use stale or contaminated gasoline or an oil/gasoline mixture. Avoid getting dirt or water in the fuel tank.

Occasionally you may hear a light “spark knock” or “pinging” (metallic rapping noise) while operating under heavy loads. This is no cause for concern.

If spark knock or pinging occurs at a steady engine speed, under normal load, change brands of gasoline. If spark knock or pinging persists, see an authorized Honda marine dealer.

NOTICE

Running the engine with persistent spark knock or pinging can cause engine damage.

Running the engine with persistent spark knock or pinging is misuse, and the *Distributor's Limited Warranty* (p. 119) does not cover parts damaged by misuse.

For information regarding oxygenated fuels, please refer to page 107.

SERVICING YOUR OUTBOARD MOTOR

Fuel Filter Inspection and Replacement

The fuel filter is located under the engine cover between the fuel coupling and the fuel pump.

Water or sediment accumulated in the filter can cause loss of power or hard starting. To prevent engine malfunction, inspect the filter and replace when necessary.

⚠ WARNING

Gasoline is highly flammable and explosive.

You can be burned or seriously injured when handling fuel.

- Stop the engine and keep heat, sparks, and flame away.
- Handle fuel only outdoors.
- Wipe up spills immediately.

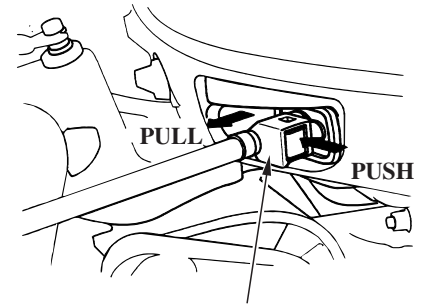

FUEL HOSE CONNECTOR

1. Disconnect the fuel hose connector from the outboard motor.
2. Remove the engine cover (p. 70).

SERVICING YOUR OUTBOARD MOTOR

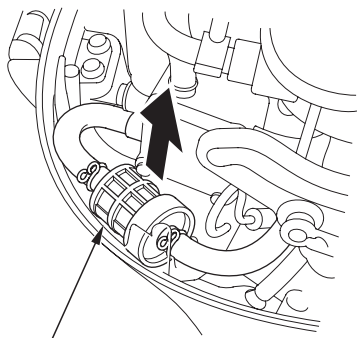

FUEL FILTER

3. Raise the fuel filter, and remove it from the engine under case.

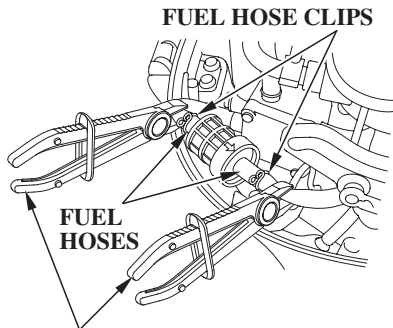

HOSE CLAMP GRIPPER
(commercially available)

4. Inspect the filter for water and/or sediment accumulation.

If the filter is OK, reinstall it. If water and/or sediment are present, replace the filter as described in the following steps. Always replace the filter at the scheduled replacement interval (p. 68).

5. Place clamps on the fuel hoses on each side of the filter to prevent fuel leakage when the fuel hoses are disconnected.

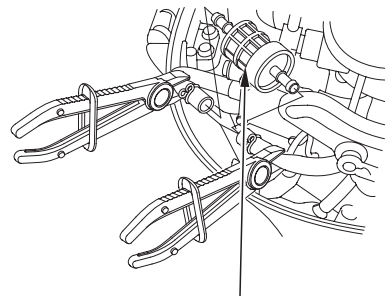

FUEL FILTER

SERVICING YOUR OUTBOARD MOTOR

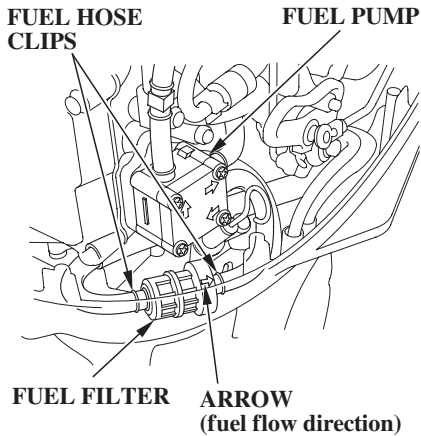

6. Install the new fuel filter so the arrow on the filter points toward the fuel pump.

Fuel flow will be reduced if the filter is installed backward.

7. Connect the fuel hoses to the filter securely with the hose clips. Remove the fuel hose clamps used to close the fuel hoses.

8. Securely connect the fuel hose connector to the outboard motor (refer to page 42).

9. Prime the engine using the priming bulb (p. 43). Check for fuel leaks. Repair any fuel leaks if necessary.

If loss of power or hard starting are found to be caused by excessive water or sediment accumulation in the fuel filter, inspect the fuel tank.

Clean the fuel tank and tank filter if necessary. It may be necessary to drain the fuel tank completely and refill with fresh gasoline.

Portable Fuel Tank and Filter Cleaning

⚠ WARNING

Gasoline is highly flammable and explosive.

You can be burned or seriously injured when handling fuel.

- Stop the engine and keep heat, sparks, and flame away.
- Handle fuel only outdoors.
- Wipe up spills immediately.

SERVICING YOUR OUTBOARD MOTOR

Fuel Tank

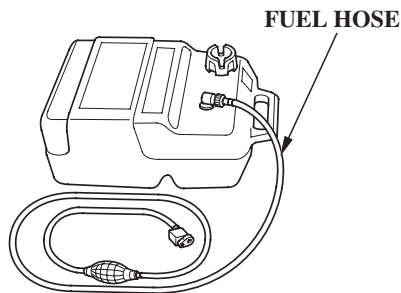

Empty the portable fuel tank into an approved gasoline container. Use a funnel to avoid spilling fuel. Rinse the fuel tank with nonflammable solvent to remove any accumulated sediment.

Fuel Tank Filter

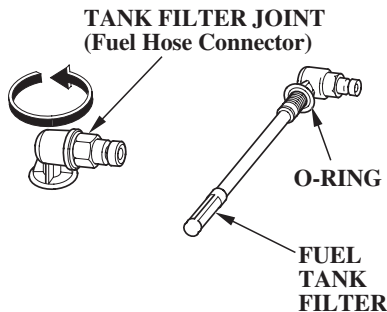

1. Unscrew the fuel hose connector by turning it counterclockwise, then remove the fuel hose connector and fuel tank filter from the tank.
2. Clean the filter in nonflammable solvent. Inspect the fuel tank filter and the connector O-ring. Replace them if damaged.
3. Reinstall the filter and hose connector in the fuel tank. Tighten the hose connector securely.

Anode Replacement

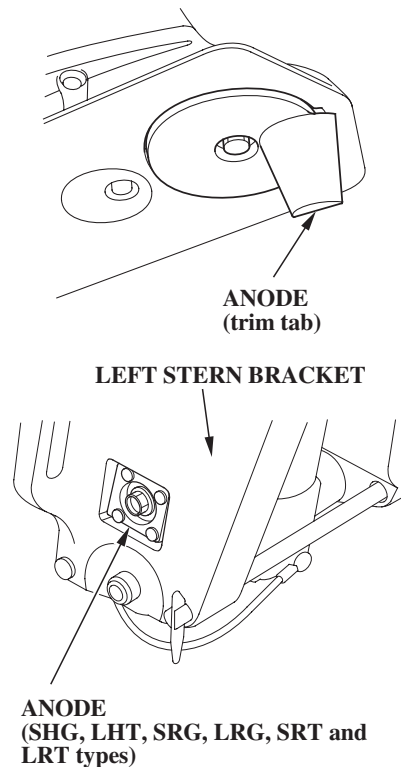

One anode is located on the stern bracket and the other anode is the trim tab. They are made of a sacrificial material that helps to protect the outboard motor from corrosion.

Replace the anodes when they have been reduced to about half their original size, or if they are crumbling.

NOTICE

Painting or coating the anodes will defeat their purpose and will lead to rust and corrosion damage to the outboard motor. The anodes must be exposed to the water in order to protect the outboard motor.

SERVICING YOUR OUTBOARD MOTOR

Propeller Replacement

Before replacing the propeller, remove the clip from the emergency stop switch to prevent any possibility of the engine being started while you are working with the propeller.

The propeller blades may have sharp edges, so wear heavy gloves to protect your hands.

Operating the outboard motor at higher altitudes will reduce available power. This may require decreasing the propeller pitch to maintain correct engine RPM.

Removal

Remove the cotter pin, unscrew the castle nut, remove the washer, then remove the propeller and thrust washer.

Installation

Install the propeller in the reverse order of removal.

- Install the thrust washer with the grooved side toward the gear case.
- Use a genuine Honda stainless steel cotter pin or equivalent cotter pin and bend the pin ends as shown.

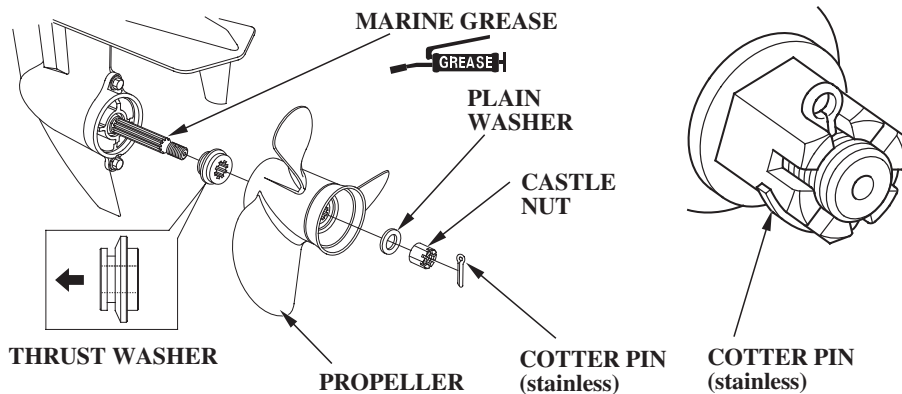

STORAGE PREPARATION

Proper storage preparation is essential for keeping your outboard motor trouble-free and looking good. The following steps will help to keep rust and corrosion from impairing your outboard motor's function and appearance, and will make the engine easier to start when you use the outboard motor again.

Cleaning and Flushing

Thoroughly clean and flush the outboard motor with fresh water after operation in dirty water or salt water.

Touch up any damaged paint, and coat areas that may rust with Honda Corrosion Inhibitor, or equivalent. Lubricate controls with a silicone spray lubricant.

Cleaning

Wash the outside of the outboard motor with clean, fresh water, and flush the cooling system as described.

Flushing With the Honda Garden Hose Adapter (optional equipment)

It is necessary to run the engine during the flushing procedure. For safety, remove the propeller from the outboard motor (p. 84).

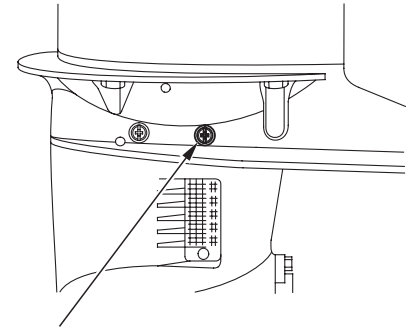

WASH PLUG (flush plug)

1. Remove the wash plug and sealing washer from the WASH plug hole in the gear case. Be sure not to remove the oil level plug from the OIL LEVEL plug hole in the gear case.

STORAGE

**GARDEN HOSE ADAPTER
(FLUSH KIT COUPLER)**

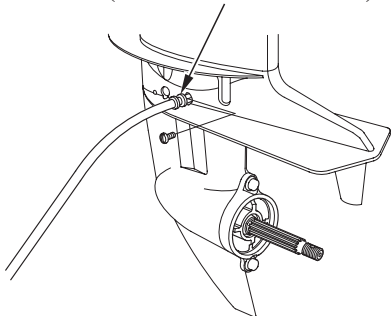

2. Remove the sealing washer from the wash plug and install the sealing washer on the flush kit coupler.
3. Install the flush kit coupler into the WASH plug hole and connect a fresh water hose to the garden hose adapter.

4. Move the gearshift lever or control lever to the N (neutral) position. Flush the outboard motor in the neutral position only.
5. Turn on the fresh water supply to the flush kit coupler.

NOTICE

Running the engine without good water circulation can cause overheating and water pump damage.

Damage caused by running the outboard motor without sufficient cooling water is not covered by the *Distributor's Limited Warranty* (p. 119).

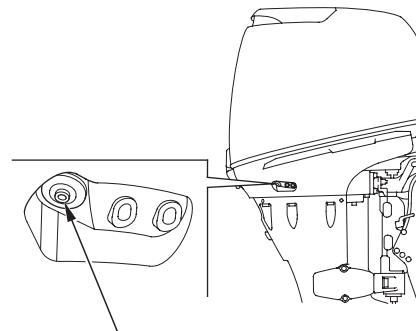

COOLING SYSTEM INDICATOR

6. Start the engine. Monitor the cooling system indicator. Stop the engine if water does not come out of the cooling system indicator and check the fresh water supply.

If the fresh water supply is insufficient it may be necessary to temporarily cover the three water intakes with duct tape as shown on the following page.

WATER INTAKES

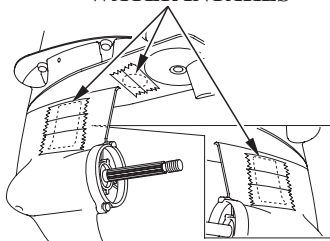

7. Allow the engine to run at idle for at least 5 minutes to clean the inside of the motor.
8. Stop the motor and remove the garden hose adapter.
9. Remove the sealing washer from the garden hose adapter and install the sealing washer on the wash plug.

If tape was used to cover the three water intakes in step 6, remove the tape now.

10. Install the wash plug into the gear case securely.

Flushing Without the Honda Garden Hose Adapter

It is necessary to run the engine during the flushing procedure. For safety, remove the propeller from the outboard motor (p. 84).

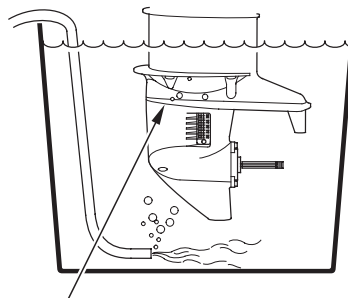

ANTIVENTILATION PLATE

1. Place a container under the outboard motor, and fill it with clean, fresh water. The water level must be at least 2 inches above the antiventilation plate.

NOTICE

Running the engine without good water circulation can cause overheating and water pump damage.

Damage caused by running the outboard motor without sufficient cooling water is not covered by the *Distributor's Limited Warranty* (p. 119).

2. Start the engine and run in the N (neutral) position at low speed for at least 10 minutes.
3. After flushing, stop the engine, remove the water container, and reinstall the propeller (p. 84).

STORAGE

Fuel

NOTICE

Depending on the region where you operate your outboard, fuel formulations may deteriorate and oxidize rapidly. Fuel deterioration and oxidation can occur in as little as 15 days and may cause damage to the carburetors and fuel system. Please check with your servicing dealer for local storage recommendations.

Gasoline will oxidize and deteriorate in storage. Old gasoline will cause hard starting, and it leaves gum deposits that clog the fuel system. If the gasoline in your fuel tank and carburetor deteriorates during storage, you may need to have the carburetor and other fuel system components serviced or replaced.

The length of time that gasoline can be left in your fuel tank and carburetor without causing functional problems will vary with such factors as gasoline blend, your storage temperatures, and whether the fuel tank is partially or completely filled. The air in a partially filled fuel tank promotes fuel deterioration. Very warm storage temperatures accelerate fuel deterioration. Fuel deterioration problems may occur in less than 30 days, if the gasoline was not fresh when you filled the fuel tank.

Adding a Fuel Stabilizer

When adding a fuel stabilizer, fill the fuel tank with fresh gasoline. If only partially filled, air in the tank will promote fuel deterioration during storage. If you keep an additional container of gasoline for refueling, be sure that it contains only fresh gasoline.

1. Add fuel stabilizer following the manufacturer's instructions.
2. After adding a fuel stabilizer, run the engine in water for 10 minutes to be sure that the treated gasoline has replaced the untreated gasoline in the carburetor.
3. Turn the engine OFF.

The *Distributor's Limited Warranty* (p. 119) does not cover fuel system damage or engine performance problems resulting from neglected storage preparation.

Draining the Fuel System

You can avoid fuel deterioration problems by draining the fuel tank and carburetors.

1. Disconnect the fuel hose from the outboard motor.

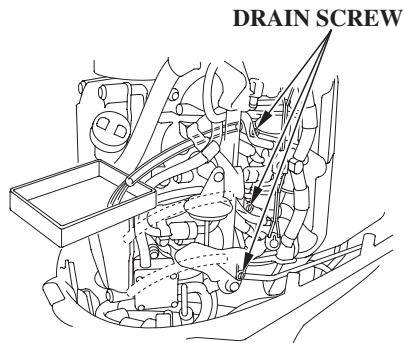

2. With the outboard motor in a vertical position, place an approved gasoline container below the fuel drain outlet, and use a funnel to avoid spilling fuel.

⚠ WARNING

Gasoline is highly flammable and explosive.

You can be burned or seriously injured when handling fuel.

- Stop the engine and keep heat, sparks, and flame away.
- Handle fuel only outdoors.
- Wipe up spills immediately.

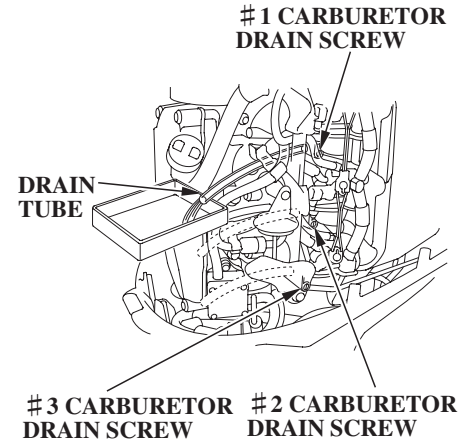

3. Loosen the drain screw on # 1 carburetor, allow the carburetor to drain completely, then tighten the drain screw securely.
4. Remove the drain tube from # 1 carburetor, install it on # 2 carburetor, and drain that carburetor in the same manner.

STORAGE

5. Repeat this procedure to drain # 3 carburetor.
6. After all three carburetors are drained, reinstall the drain tube on # 1 carburetor.
7. Drain the fuel tank into an approved gasoline container, or if you need to store fuel in the fuel tank, you can extend fuel storage life by filling the fuel tank with fresh gasoline and adding a fuel stabilizer that is formulated for that purpose.

If using the portable fuel tank, firmly close the fuel filler cap vent knob.

Engine Oil

1. Change the engine oil (p. 72).
2. Remove the spark plugs (p. 75), and remove the clip from the emergency stop switch.
3. Pour a tablespoon (5 – 10 cm³) of clean engine oil into each cylinder.
4. Using the emergency starter rope (p. 49), rotate the flywheel a few revolutions to distribute the oil in the cylinders.
5. Reinstall the spark plugs (p. 76).

STORAGE PRECAUTIONS

Select a well-ventilated storage area. If possible, avoid storage areas with high humidity.

If storing a container of gasoline, such as the portable fuel tank, store it away from any appliance that operates with a flame, such as a furnace, water heater, or clothes dryer. Also avoid any area with a spark producing electric motor, or where power tools are operated.

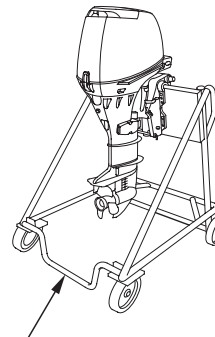

OUTBOARD MOTOR STAND
(commercially available)

If the outboard motor will be removed from the boat for storage, we recommend storing it vertically by mounting it on a commercially available stand.

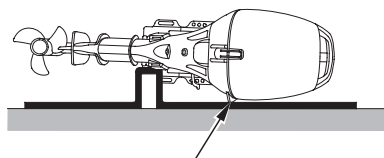

CASE PROTECTOR

If it is necessary to store the outboard motor horizontally, drain the carburetor (p. 89), and drain the engine oil (p. 72), before removing the outboard motor from the boat.

Position the outboard motor with its carburetor side down, and cushion it with protective packing material.

Cover the outboard motor to keep out dust. Do not use sheet plastic as a dust cover. A nonporous cover will trap moisture, promoting rust and corrosion.

REMOVAL FROM STORAGE

Check your outboard motor as described in the *BEFORE OPERATION* chapter of this manual.

If the cylinders were coated with oil during storage preparation, the engine may smoke briefly at startup. This is normal.

TRANSPORTING

WITH OUTBOARD MOTOR INSTALLED ON BOAT

When trailering a boat with the outboard motor attached, leave the engine in the normal running position, if possible.

SH, LH, SHG and LHT Types

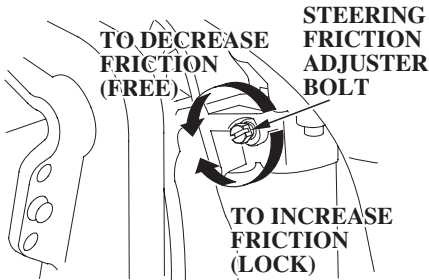

(SH and LH types)

STEERING FRICTION ADJUSTER

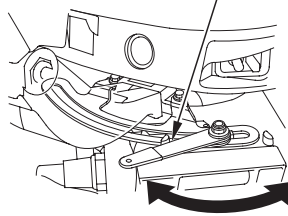

TO INCREASE
FRICTION
(LOCK)

TO DECREASE
FRICTION
(FREE)

(SHG and LHT types)

Tighten the steering friction adjuster to prevent the outboard motor from moving while trailering the boat.

SRG, LRG, SRT and LRT Types (remote control)

Use a motor support bar to prevent the outboard motor from moving while trailering the boat. Refer to the manufacturer's instructions for using a motor support bar.

All Types

If there is insufficient road clearance in the normal running position, then tilt the outboard motor and use a motor support bar, or remove the outboard motor from the boat. Refer to the manufacturer's instructions for using a motor support bar.

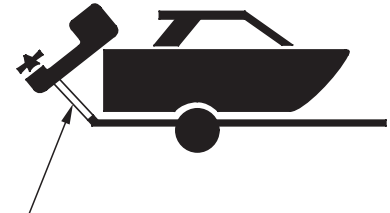

MOTOR SUPPORT BAR
(commercially available)

WITH OUTBOARD MOTOR REMOVED FROM BOAT

Secure the outboard motor in either the vertical or horizontal position shown on p. 91 .

(Tiller handle type)

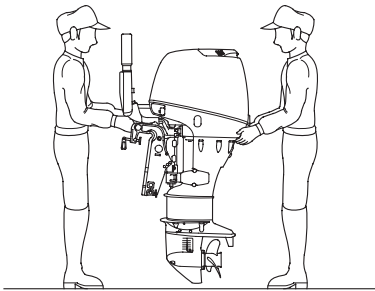
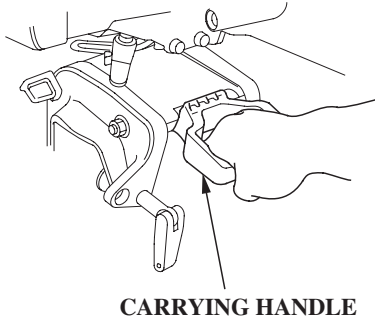
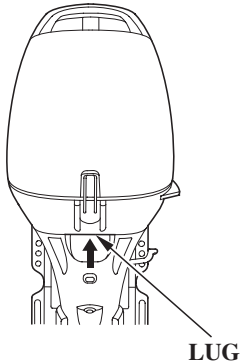

To carry, hold the outboard motor by the carrying handle, or hold by the carrying handle and the lug beneath engine cover lock lever, as shown.

NOTICE

Lifting the outboard motor by the engine cover, or using the installed outboard motor as a handle or lever to move the boat, can damage the outboard motor.

TRANSPORTING

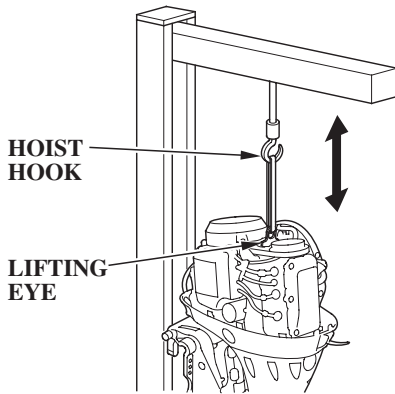

When transporting the outboard motor on a vehicle, perform the following.

1. Remove the engine cover, lift the outboard motor using the engine lifting eye, and place on the outboard motor stand (commercially available).

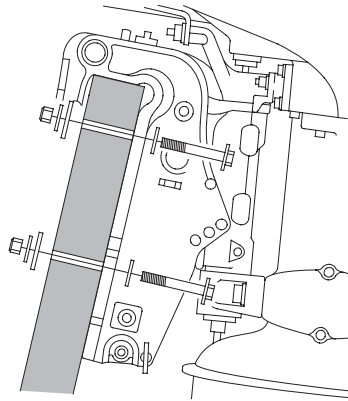

2. Secure the outboard motor with the bolts, nuts and washers.

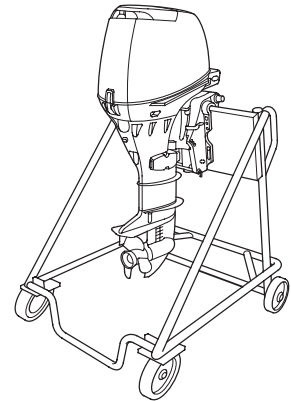

3. Reinstall the engine cover.

When trailing or transporting the boat with the motor attached, it is recommended that the motor remain in normal running position, with the steering friction adjuster in the locked position (p. 92).

TAKING CARE OF UNEXPECTED PROBLEMS

ELECTRIC STARTER WILL NOT OPERATE	Possible Cause	Correction
1. Check battery.	Battery connections loose or corroded.	Clean and tighten battery connections.
	Battery discharged.	Recharge battery.
2. Check fuse.	Fuse burnt out.	Replace fuse (p.100).
3. Use emergency starting procedure (p. 48), then take outboard motor to an authorized Honda marine dealer, or refer to the shop manual.	Starter malfunction, switch malfunction, or electrical problem in the starting circuit.	Replace or repair faulty components as necessary.

TAKING CARE OF UNEXPECTED PROBLEMS

ENGINE WILL NOT START	Possible Cause	Correction
1. Check emergency stop switch clip.	Clip not inserted in stop switch.	Insert clip in stop switch.
2. Check control positions.	Gearshift lever or control lever not in neutral position.	Shift to neutral (p. 44 or 46).
	Throttle grip not in START position (long tiller handle type).	Turn throttle grip to START position (p. 44).
	Fast idle lever raised (remote control/side-mount type).	Lower fast idle lever, if the engine is warm (p. 47).

TAKING CARE OF UNEXPECTED PROBLEMS

ENGINE WILL NOT START (continued)	Possible Cause	Correction
3. Check fuel.	Out of fuel.	Refuel (p. 77).
	Fuel vent closed (portable fuel tank).	Open the vent knob (p. 42).
	Fuel hose not primed.	Squeeze priming bulb (p. 43).
	Fuel filter or fuel tank filter clogged.	Replace fuel filters (p. 79 and 81).
	Bad fuel; boat stored without treating or draining gasoline, or refueled with bad gasoline.	Drain fuel tank and carburetors (p. 89 and 90). Refill with fresh gasoline (p. 77).
4. Remove and inspect spark plugs.	Spark plugs faulty, fouled or improperly gapped.	Gap or replace spark plugs (p. 75).
	Spark plugs wet with fuel (flooded engine).	Dry and reinstall spark plugs. Start engine with the throttle open.
5. Take outboard motor to an authorized Honda marine dealer, or refer to the shop manual.	Carburetor malfunction, fuel pump failure, ignition malfunction, stuck valves, etc.	Replace or repair faulty components as necessary.

TAKING CARE OF UNEXPECTED PROBLEMS

HARD STARTING OR STALLS AFTER STARTING	Possible Cause	Correction
1. Check control positions.	Throttle grip not in START position (long tiller handle type).	Turn throttle grip to START position (p. 44).
	Fast idle lever raised (remote control/side-mount type).	Lower fast idle lever, unless engine is warm (p. 47).
2. Check fuel.	Fuel vent closed (portable fuel tank).	Open the vent knob (p. 42).
	Fuel hose not primed.	Squeeze priming bulb (p. 43).
	Fuel filter or fuel tank filter clogged.	Replace fuel filters (p. 79 and 81).
	Bad fuel; boat stored without treating or draining gasoline, or refueled with bad fuel.	Drain fuel tank and carburetors (p. 89 and 90). Refill with fresh gasoline (p. 77).

TAKING CARE OF UNEXPECTED PROBLEMS

HARD STARTING OR STALLS AFTER STARTING (continued)	Possible Cause	Correction
3. Remove and inspect spark plugs.	Spark plugs faulty, fouled or improperly gapped.	Gap or replace spark plugs (p. 75).
4. Take outboard motor to an authorized Honda marine dealer, or refer to the shop manual.	Carburetor malfunction, fuel pump failure, ignition malfunction, etc.	Replace or repair faulty components as necessary.

ENGINE OVERHEATS	Possible Cause	Correction
1. Check water intake screens.	Water intake screens clogged.	Clean water intake screens.
2. Take outboard motor to an authorized Honda marine dealer, or refer to the shop manual.	Faulty thermostat or water pump.	Replace or repair faulty components as necessary.

TAKING CARE OF UNEXPECTED PROBLEMS

BATTERY WILL NOT CHARGE AND ELECTRIC STARTER WILL NOT OPERATE

The battery-charging circuit and the electric starter relay circuit are protected by the 15-ampere fuse. If the fuse burns out, the engine will not charge the battery, and the electric starter will not operate. The engine can be started using the emergency starter rope.

The ignition switch is protected by the 10-ampere fuse. If the fuse burns out, the engine will not start or run, and the power trim/tilt switch will not operate.

Fuse Replacement

1. With the engine stopped, remove the engine cover.
2. Remove the fuse cover.

3. Remove and inspect the fuse. If a fuse is burnt out, install a replacement fuse of the specified rating. The outboard motor is supplied with a spare fuse in each fuse holder.

DESIGNATED FUSE: 15A, 10A

NOTICE

Never use a fuse with a rating greater than specified. Serious damage to the electrical system could result.

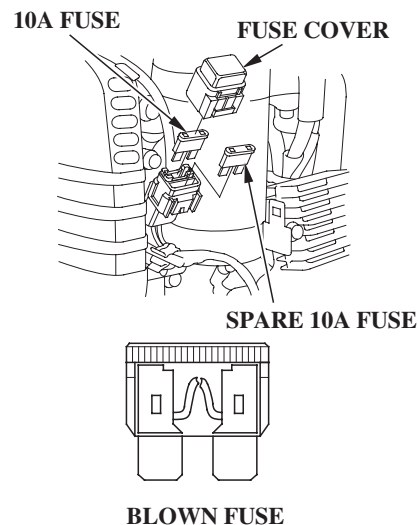
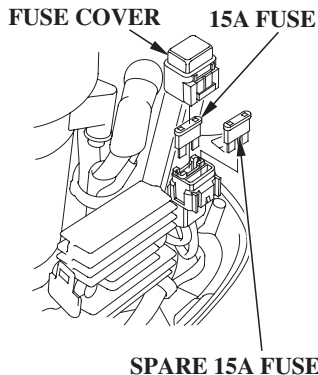

4. Reinstall the fuse cover and the engine cover.

Before further operation, try to determine and correct the electrical problem that caused the fuse to burn out. An uncorrected electrical problem may cause the fuse to burn out again.

TAKING CARE OF UNEXPECTED PROBLEMS

OIL PRESSURE INDICATOR LIGHT GOES OFF AND ENGINE SPEED IS LIMITED

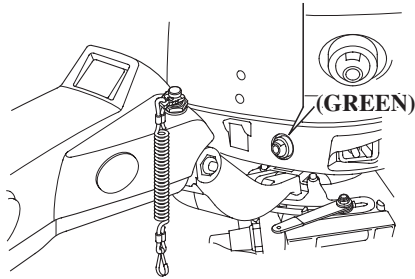

(long tiller handle/SH and LH types)

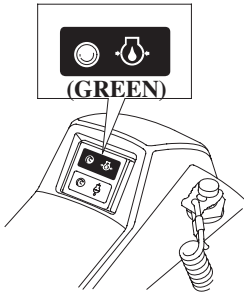

(long tiller handle/SHG and LHT types)

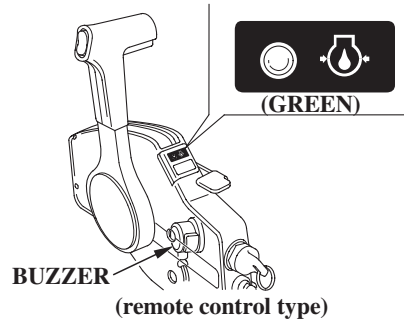

If oil pressure becomes low, the green indicator light will go off, and the engine protection system will limit engine speed. If you are at cruising speed, engine speed will decrease gradually.

Remote control type is equipped with a buzzer that sounds continuously when the green indicator light goes off.

The buzzer sound stops below an engine speed of 1,400 rpm.

Low oil pressure may be the result of a low engine oil level, or there may be a problem with the engine lubrication system.

If the throttle is closed suddenly after full throttle operation, engine speed may drop below the specified idle rpm, and that could activate the engine protection system momentarily.

If low oil pressure activates the engine protection system, stop the engine, check the engine oil level (p. 71), and add oil if needed.

With the engine oil at the recommended level, restart the engine. If the lubrication system is OK, the green indicator light should come on within 30 seconds, and the engine will respond normally to throttle grip or control lever operation.

If the engine protection system remains activated after 30 seconds, return to the nearest boat landing, and have the outboard motor inspected by an authorized Honda marine dealer.

TAKING CARE OF UNEXPECTED PROBLEMS

OVERHEAT INDICATOR LIGHT COMES ON AND ENGINE SPEED IS LIMITED

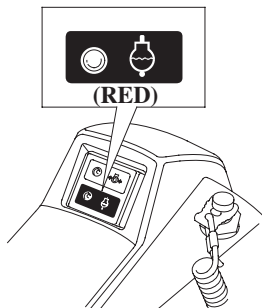

(long tiller handle/SHG and LHT types)

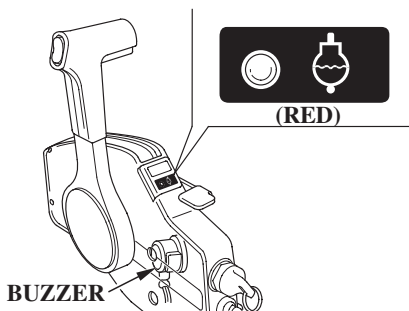

(remote control type)

If the engine overheats, the red indicator light will come on, and the engine protection system will limit engine speed. If you are at cruising speed, engine speed will decrease gradually.

When normal engine temperature is restored, the engine speed will gradually rise to normal engine speed.

If the condition persists for another 20 seconds, the engine will shut off.

Remote control types are equipped with a buzzer that sounds when the red indicator light comes on.

Engine overheating may be the result of clogged water intake screens, or there may be a problem with the cooling system thermostat or water pump.

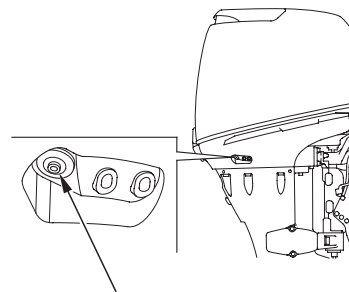

COOLING SYSTEM INDICATOR

If overheating activates the engine protection system, idle the engine in neutral, and check the cooling system indicator.

If water is flowing from the cooling system indicator, continue idling for 30 seconds. If the cooling system is OK, the red indicator light should go off within 30 seconds, and the engine will respond normally to throttle grip or control lever operation.

TAKING CARE OF UNEXPECTED PROBLEMS

If there is no water flowing from the cooling system indicator, stop the engine, and tilt the outboard motor to inspect the water intake screens. If clogged, clean the water intake screens, return the outboard motor to the running position, restart the engine, and check the cooling system indicator again.

If there is still no water flowing from the cooling system indicator, or if the engine protection system remains activated after 30 seconds, return to the nearest boat landing, and have the outboard motor inspected by an authorized Honda marine dealer.

SUBMERGED MOTOR

A submerged outboard motor must be serviced immediately after it is recovered from the water in order to minimize corrosion.

If there is a Honda marine dealer nearby, take the motor to the dealer immediately. If you are far from a dealer, proceed as follows:

1. Remove the engine cover, and rinse the outboard motor with fresh water to remove salt water, sand, mud, etc.
2. Drain the carburetors as described on p. 89.

3. Change the engine oil as described on p. 72 – 73 . If there was water in the engine crankcase, or if the used engine oil showed signs of water contamination, then a second engine oil change should be performed after running the engine for half an hour.

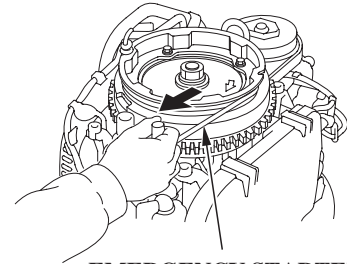

EMERGENCY STARTER ROPE

4. Remove the recoil starter assembly or flywheel cover (p. 49). Remove the spark plugs (p. 75), and remove the clip from the emergency stop switch. Pull the emergency starter rope, rotate the flywheel a few revolutions to completely expel any water from the cylinders.

TAKING CARE OF UNEXPECTED PROBLEMS

If the engine was running when it submerged, there may be mechanical damage, such as bent connecting rods. If the engine binds when cranked, do not attempt to run the engine until it has been repaired.

NOTICE

When cranking the engine with an open ignition circuit (spark plugs removed from the ignition circuit), remove the clip from the emergency stop switch to prevent possible damage to the ignition system.

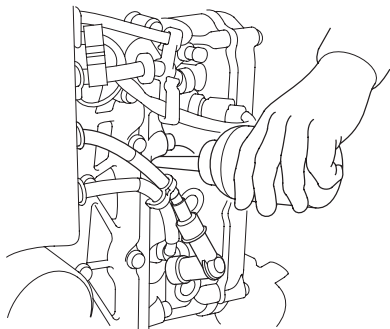

5. Pour a teaspoon of engine oil into each spark plug hole, then pull the emergency starter rope several times to lubricate the inside of the cylinders.
6. Reinstall the spark plugs, and put the emergency stop switch clip into the switch.

7. Attempt to start the engine.

If the engine fails to start, remove the spark plugs, dry them, then reinstall the spark plugs and attempt to start the engine again.

If the engine starts, and no mechanical damage is evident, continue to run the engine for a half hour or longer. Be sure the water level is at least two inches above the antivibration plate to avoid overheating and water pump damage.

8. As soon as possible, take the outboard motor to an authorized Honda marine dealer for inspection and service.

TECHNICAL AND CONSUMER INFORMATION

TECHNICAL INFORMATION

Serial Number Locations

Record the product identification number, the engine serial number and the date of purchase in the space provided on this page. You will need these numbers when ordering parts, and when making technical or warranty inquiries (p. 116).

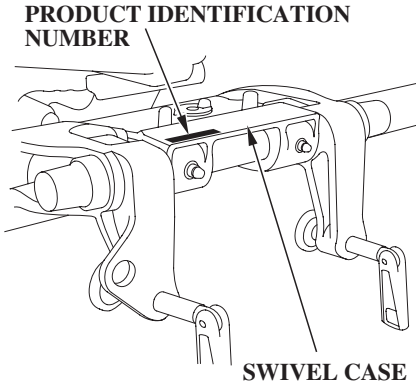

The product identification number is stamped on a plate attached on top of the swivel case.

Product identification number:

Date of purchase:

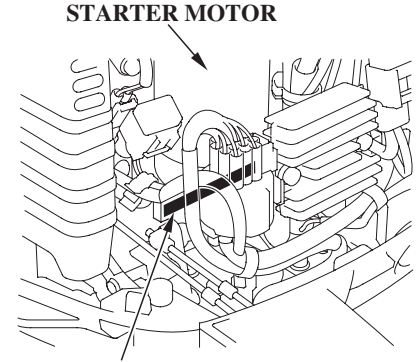

ENGINE SERIAL NUMBER

The engine serial number is stamped on the cylinder block under the starter motor which is located in the front of the engine.

Engine serial number:

TECHNICAL AND CONSUMER INFORMATION

Carburetor Modification for High Altitude Operation

At high altitude, the standard carburetor air-fuel mixture will be too rich. Performance will decrease, and fuel consumption will increase. A very rich mixture will also foul the spark plugs and cause hard starting.

High altitude performance can be improved by specific modifications to the carburetors. If you always operate your outboard motor at altitudes above 5,000 feet (1,500 meters), have an authorized Honda marine dealer perform this carburetor modification.

Even with carburetor modification, engine horsepower will decrease about 3.5% for each 1,000-foot (300-meter) increase in altitude. The effect of altitude on horsepower will be greater than this if no carburetor modification is made.

NOTICE

When the carburetors have been modified for high altitude operation, the air-fuel mixture will be too lean for low altitude use. Operation at altitudes below 5,000 feet (1,500 meters) with modified carburetors may cause the engine to overheat and result in serious engine damage. For use at low altitudes, have an authorized Honda marine dealer return the carburetors to original factory specifications.

Battery

For complete information, refer to the battery manufacturer's instructions.

Minimum Requirements

12V-65Ah (CCA 420)

TECHNICAL AND CONSUMER INFORMATION

Oxygenated Fuels

Some conventional gasolines are being blended with alcohol or an ether compound. These gasolines are collectively referred to as oxygenated fuels. To meet clean air standards, some areas of the United States and Canada use oxygenated fuels to help reduce emissions.

If you use an oxygenated fuel, be sure it is unleaded and meets the minimum octane rating requirement.

Before using an oxygenated fuel, try to confirm the fuel's contents. Some states/provinces require this information to be posted on the pump.

The following are the EPA-approved percentages of oxygenates:

ETHANOL: ethyl or grain alcohol; 10% by volume.

You may use gasoline containing up to 10% ethanol by volume. Gasoline containing ethanol may be marketed under the name "Gasohol".

MTBE: Methyl Tertiary Butyl Ether; 15% by volume.

You may use gasoline containing up to 15% MTBE by volume.

METHANOL: methyl or wood alcohol; 5% by volume.

You may use gasoline containing up to 5% methanol by volume, as long as it also contains cosolvents and corrosion inhibitors to protect the fuel system. Gasoline containing more than 5% methanol by volume may cause starting and/or performance problems. It may also

damage metal, rubber, and plastic parts of your fuel system.

If you notice any undesirable operating symptoms, try another service station, or switch to another brand of gasoline.

Fuel system damage or performance problems resulting from the use of an oxygenated fuel containing more than the percentages of oxygenates mentioned above are not covered under warranty.

TECHNICAL AND CONSUMER INFORMATION

Emission Control System Information

Source of Emissions

The combustion process produces carbon monoxide, oxides of nitrogen, and hydrocarbons. Control of hydrocarbons and oxides of nitrogen is very important because, under certain conditions, they react to form photochemical smog when subjected to sunlight. Carbon monoxide does not react in the same way, but it is toxic.

Honda utilizes lean carburetor settings and other systems to reduce the emissions of carbon monoxide, oxides of nitrogen, and hydrocarbons.

The U.S. and California Clean Air Acts

EPA and California regulations require all manufacturers to furnish written instructions describing the operation and maintenance of emission control systems.

The following instructions and procedures must be followed in order to keep the emissions from your Honda engine within the emission standards.

Tampering and Altering

Tampering with or altering the emission control system may increase emissions beyond the legal limit. Among those acts that constitute tampering are:

- Removal or alteration of any part of the intake, fuel, or exhaust systems.
- Alterations that would cause the engine to operate outside its design parameters.

Problems That May Affect Emissions

If you are aware of any of the following symptoms, have your engine inspected and repaired by your servicing dealer.

- Hard starting or stalling after starting.
- Rough idle.
- Misfiring or backfiring under load.
- Afterburning (backfiring).
- Black exhaust smoke or high fuel consumption.

Replacement Parts

The emission control systems on your Honda engine were designed, built, and certified to conform with EPA and California emission regulations. We recommend the use of genuine Honda parts whenever you have maintenance done. These original-design replacement parts are manufactured to the same standards as the original parts, so you can be confident of their performance. The use of replacement parts that are not of the original design and quality may impair the effectiveness of your emission control system.

A manufacturer of an aftermarket part assumes the responsibility that the part will not adversely affect emission performance. The manufacturer or rebuilder of the part must certify that use of the part will not result in a failure of the engine to comply with emission regulations.

Maintenance

Follow the maintenance schedule on p. 67. Remember that this schedule is based on the assumption that your machine will be used for its designed purpose. Sustained high-load operation, or use in unusual conditions, will require more frequent service.

TECHNICAL AND CONSUMER INFORMATION

Star Label

A Star label was applied to this outboard motor in accordance with the requirements of the California Air Resources Board.

The Star Label means Cleaner Marine Engine

This engine has been certified as a:



The Symbol for Cleaner Marine Engines:

Cleaner Air and Water - for healthier lifestyle and environment.

Better Fuel Economy - burns up to 30 - 40 percent less gas and oil than conventional carbureted two-stroke engines, saving money and resources.

Longer Emission Warranty - protects consumer for worry-free operation.

TECHNICAL AND CONSUMER INFORMATION



One Star Low Emission

The one-star label identifies engines that meet the Air Resources Board's Personal Watercraft and Outboard marine engine 2001 exhaust emission standards. Engines meeting these standards have 75% lower emissions than conventional carbureted two-stroke engines. These engines are equivalent to the U.S. EPA's 2006 standards for marine engines.



Two Stars Very Low Emission

The two-star label identifies engines that meet the Air Resources Board's Personal Watercraft and Outboard marine engine 2004 exhaust emission standards. Engines meeting these standards have 20% lower emissions than One Star-Low Emission engines.



Three Stars Ultra Low Emission

The three-star label identifies engines that meet the Air Resources Board's Personal Watercraft and Outboard marine engine 2008 exhaust emission standards or the Sterndrive and inboard marine engine 2003-2008 exhaust emission standards. Engines meeting these standards have 65% lower emissions than One Star-Low Emission engines.



Four Stars Super Ultra Low Emission

The four-star label identifies engines that meet the Air Resources Board's Sterndrive and Inboard marine engine 2009 exhaust emission standards. Personal Watercraft and Outboard marine engines may also comply with these standards. Engines meeting these standards have 90% lower emissions than One Star-Low Emission engines.

Cleaner Watercraft - Get the Facts
1-800-END-SMOG
www.arb.ca.gov

TECHNICAL AND CONSUMER INFORMATION

Specifications

MODEL	BF25D		
Description Code	BATJ		
Type	H	HG	HT
Overall length	28.3 in (720 mm)		
Overall width	14.8 in (375 mm)		
Overall height	S	47.0 in (1,195 mm)	
	L	52.0 in (1,320 mm)	
Transom height	S	17.0 in (431 mm)	
	L	21.7 in (552 mm)	
Weight	S	155.4 lbs (70.5 kg)	176.4 lbs (80.0 kg)
	L	159.8 lbs (72.5 kg)	185.2 lbs (84.0 kg)
Rated power	18.7 kW (25 HP)		
Full throttle range	5,000 – 6,000 rpm		
Engine type	4 stroke OHC in-line 3 cylinder		
Displacement	33.7 cu-in (552 cm ³)		
Starter system	Recoil starter	Electric starter	
Ignition system	Digital ICM (Ignition Control Module)		
Lubrication system	Trochoid pump pressure lubrication		
Specified oil	Engine: API standard (Fuel Efficient SG, SH, SJ, SL) SAE 5W-30 Gear case: API standard (GL-4/5) SAE 90 outboard motor gear oil		

Oil capacity	Engine: 1.7 US qt (1.6 ℓ) Without oil filter change Gear case: 0.29 US qt (0.27 ℓ)	
CARB star label	ULTRA LOW EMISSION	
D.C. output	12V – 4A	12V – 10A
Cooling system	Water cooling with thermostat	
Exhaust system	Thru-hub	
Spark plugs	DR7EA (NGK) X22ESR-U (DENSO)	
Fuel pump	Diaphragm type	
Fuel	Automotive unleaded gasoline (86 pump octane or higher)	
Tank capacity	6.6 US gal (25 ℓ)	
Gear change	Forward-Neutral-Reverse (dog type)	
Steering angle	40° right and left	
Transom angle	5 stages (4°, 8°, 12°, 16°, 20°)	4 stages (8°, 12°, 16°, 20°)
	Tilt angle (transom angle at 12°)	3 stages (20°, 37°, 67°)

Tuneup

Spark plug gap	0.024 – 0.028 in (0.60 – 0.70 mm)	See page 75
Idle speed	950 ± 50 rpm	See shop manual
Valve clearance (cold)	Intake: 0.12 ± 0.02 mm Exhaust: 0.20 ± 0.02 mm	See shop manual
Other specifications	No other adjustment is needed	

Honda outboards are power rated in accordance with NMMA procedures and using the ICOMIA standard 28/23.

TECHNICAL AND CONSUMER INFORMATION

Specifications

MODEL	BF25D	
Description Code	BATJ	
Type	RG	RT
Overall length	25.2 in (640 mm)	
Overall width	14.8 in (375 mm)	
Overall height	S	47.0 in (1,195 mm)
	L	52.0 in (1,320 mm)
Transom height	S	17.0 in (431 mm)
	L	21.7 in (552 mm)
Weight	S	166.4 lbs (75.5 kg)
	L	170.9 lbs (77.5 kg)
Rated power	18.7 kW (25 HP)	
Full throttle range	5,000 – 6,000 rpm	
Engine type	4 stroke OHC in-line 3 cylinder	
Displacement	33.7 cu-in (552 cm ³)	
Starter system	Electric starter	
Ignition system	Digital ICM (Ignition Control Module)	
Lubrication system	Trochoid pump pressure lubrication	
Specified oil	Engine: API standard (Fuel Efficient SG, SH, SJ, SL) SAE 5W-30 Gear case: API standard (GL-4/5) SAE 90 outboard motor gear oil	

Oil capacity	Engine: 1.7 US qt (1.6 ℓ) Without oil filter change Gear case: 0.29 US qt (0.27 ℓ)
CARB star label	ULTRA LOW EMISSION
D.C. output	12V – 10A
Cooling system	Water cooling with thermostat
Exhaust system	Thru-hub
Spark plugs	DR7EA (NGK) X22ESR-U (DENSO)
Fuel pump	Diaphragm type
Fuel	Automotive unleaded gasoline (86 pump octane or higher)
Tank capacity	6.6 US gal (25 ℓ)
Gear change	Forward-Neutral-Reverse (dog type)
Steering angle	40° right and left
Transom angle	4 stages (8°, 12°, 16°, 20°)
Tilt angle (transom angle at 12°)	Stageless (–4° to 64°)

Tuneup

Spark plug gap	0.024 – 0.028 in (0.60 – 0.70 mm)	See page 75
Idle speed	950 ± 50 rpm	See shop manual
Valve clearance (cold)	Intake: 0.12 ± 0.02 mm Exhaust: 0.20 ± 0.02 mm	See shop manual
Other specifications	No other adjustment is needed	

Honda outboards are power rated in accordance with NMMA procedures and using the ICOMIA standard 28/23.

TECHNICAL AND CONSUMER INFORMATION

Specifications

MODEL	BF30D		
Description Code	BAUJ		
Type	H	HG	HT
Overall length	28.3 in (720 mm)		
Overall width	14.8 in (375 mm)		
Overall height	S	47.0 in (1,195 mm)	
	L	52.0 in (1,320 mm)	
Transom height	S	17.0 in (431 mm)	
	L	21.7 in (552 mm)	
Weight	S	176.4 lbs (80.0 kg)	
	L	159.8 lbs (72.5 kg)	185.2 lbs (84.0 kg)
Rated power	22.4 kW (30 HP)		
Full throttle range	5,000 – 6,000 rpm		
Engine type	4 stroke OHC in-line 3 cylinder		
Displacement	33.7 cu-in (552 cm ³)		
Starter system	Recoil starter	Electric starter	
Ignition system	Digital ICM (Ignition Control Module)		
Lubrication system	Trochoid pump pressure lubrication		
Specified oil	Engine: API standard (Fuel Efficient SG, SH, SJ, SL) SAE 5W-30 Gear case: API standard (GL-4/5) SAE 90 outboard motor gear oil		

Oil capacity	Engine: 1.7 US qt (1.6 ℓ) Without oil filler change Gear case: 0.29 US qt (0.27 ℓ)	
CARB star label	ULTRA LOW EMISSION	
D.C. output	12V – 4A	12V – 10A
Cooling system	Water cooling with thermostat	
Exhaust system	Thru-hub	
Spark plugs	DR7EA (NGK) X22ESR-U (DENSO)	
Fuel pump	Diaphragm type	
Fuel	Automotive unleaded gasoline (86 pump octane or higher)	
Tank capacity	6.6 US gal (25 ℓ)	
Gear change	Forward-Neutral-Reverse (dog type)	
Steering angle	40° right and left	
Transom angle	5 stages (4°, 8°, 12°, 16°, 20°)	4 stages (8°, 12°, 16°, 20°)
	Tilt angle (transom angle at 12°)	3 stages (20°, 37°, 67°)

Tuneup

Spark plug gap	0.024 – 0.028 in (0.60 – 0.70 mm)	See page 75
Idle speed	950 ± 50 rpm	See shop manual
Valve clearance (cold)	Intake: 0.12 ± 0.02 mm Exhaust: 0.20 ± 0.02 mm	See shop manual
Other specifications	No other adjustment is needed	

Honda outboards are power rated in accordance with NMMA procedures and using the ICOMIA standard 28/23.

TECHNICAL AND CONSUMER INFORMATION

Specifications

MODEL	BF30D	
Description Code	BAUJ	
Type	RG	RT
Overall length	25.2 in (640 mm)	
Overall width	14.8 in (375 mm)	
Overall height	S	47.0 in (1,195 mm)
	L	52.0 in (1,320 mm)
Transom height	S	17.0 in (431 mm)
	L	21.7 in (552 mm)
Weight	170.9 lbs (77.5 kg)	
	L	175.3 lbs (79.5 kg)
Rated power	22.4 kW (30 HP)	
Full throttle range	5,000 – 6,000 rpm	
Engine type	4 stroke OHC in-line 3 cylinder	
Displacement	33.7 cu-in (552 cm ³)	
Starter system	Electric starter	
Ignition system	Digital ICM (Ignition Control Module)	
Lubrication system	Trochoid pump pressure lubrication	
Specified oil	Engine: API standard (Fuel Efficient SG, SH, SJ, SL) SAE 5W-30 Gear case: API standard (GL-4/5) SAE 90 outboard motor gear oil	

Oil capacity	Engine: 1.7 US qt (1.6 ℓ) Without oil filter change Gear case: 0.29 US qt (0.27 ℓ)
CARB star label	ULTRA LOW EMISSION
D.C. output	12V – 10A
Cooling system	Water cooling with thermostat
Exhaust system	Thru-hub
Spark plugs	DR7EA (NGK) X22ESR-U (DENSO)
Fuel pump	Diaphragm type
Fuel	Automotive unleaded gasoline (86 pump octane or higher)
Tank capacity	6.6 US gal (25 ℓ)
Gear change	Forward-Neutral-Reverse (dog type)
Steering angle	40° right and left
Transom angle	4 stages (8°, 12°, 16°, 20°)
Tilt angle (transom angle at 12°)	Stageless (–4° to 64°)

Tuneup

Spark plug gap	0.024 – 0.028 in (0.60 – 0.70 mm)	See page 75
Idle speed	950 ± 50 rpm	See shop manual
Valve clearance (cold)	Intake: 0.12 ± 0.02 mm Exhaust: 0.20 ± 0.02 mm	See shop manual
Other specifications	No other adjustment is needed	

Honda outboards are power rated in accordance with NMMA procedures and using the ICOMIA standard 28/23.

TECHNICAL AND CONSUMER INFORMATION

CONSUMER INFORMATION

Honda Publications

These publications will give you additional information for maintaining and repairing your outboard motor. You may purchase them from your Honda marine dealer.

Shop Manual

This manual covers complete maintenance and overhaul procedures. It is intended to be used by a skilled technician.

Parts Catalog

This manual provides complete, illustrated parts lists.

Customer Service Information

Contacting Honda

Your owner's manual was written to cover most of the questions you might ask about your Honda. Any questions not answered in the owner's manual can be answered by your Honda dealer. If your dealer doesn't have an immediate answer, they should be able to get it for you.

If you have a difference of opinion with your dealer, please remember that each dealership is independently owned and operated. That's why it's important to work to resolve any differences at the dealership level. If the service personnel are unable to assist you, please discuss your concerns with the dealer management such as the Service Manager or Dealer Owner.

If you need to contact American Honda regarding your experiences with your Honda product or with

your dealer, please send your comments to the following address:

American Honda Motor Co., Inc.
Marine Division
Customer Relations Office
4900 Marconi Drive
Alpharetta, GA 30005-8847
Telephone (770)497-6400
M-F 8:30am-7:00pm (Eastern Time Zone)

TECHNICAL AND CONSUMER INFORMATION

Please include the following information in your communication:

- Your name, address and telephone number (complete with area code)
- Model and complete serial number
- Date of purchase
- Name and location of selling dealer
- Name and location of servicing dealer (if different)
- A detailed description of your concerns

We will likely ask your Honda dealer to respond, or possibly acknowledge your comments directly.

Warranty Coverage

Your new Honda is covered by the following warranties:

- Distributor's Limited Warranty
- Emission Control Warranty

Please read the warranty statements contained in this manual. There are responsibilities, restrictions, and exclusions that apply to these warranties.

To obtain warranty service you must take your Honda outboard engine, together with proof of original retail purchase date, at your expense, to a Honda engine dealer or distributor authorized to sell that product in the United States, Puerto Rico, or the U.S. Virgin Islands.

It is important to realize that your warranty applies to defects in material or workmanship of your Honda. Your warranty coverage does not apply to normal wear or

deterioration associated with using your Honda outboard.

Your warranty coverage will not be voided if you choose to perform your own maintenance. However, you should have the proper tools and service information and be mechanically qualified. Failures that occur due to modifications, improper maintenance or service are not covered.

TECHNICAL AND CONSUMER INFORMATION

Warranty Service

Please remember that recommended maintenance interval servicing is not included in your warranty coverage. Additionally, your warranty does not apply to the normal wear of items (such as spark plug(s), water pump, etc.).

As the owner of a Honda product, your servicing dealer may ask you to authorize an inspection. If the problem is covered under warranty, your dealer will perform any warranty repairs for you at no cost. However, you may be responsible for additional non-warranty charges.

If you have questions about warranty coverage or the nature of the repair, it is best to talk to the service manager of your Honda dealer.

Sometimes, in spite of the best intentions of all concerned, a misunderstanding may occur. If you aren't satisfied with your dealer's

handling of the situation, we suggest you discuss your problem with the appropriate member of the dealership's management team. If the problem has already been reviewed with the appropriate manager of the Service, Parts, or Sales department, contact the owner of the dealership or their designated representative.

TECHNICAL AND CONSUMER INFORMATION

Distributor's Limited Warranty — 2006

This warranty is limited to Honda Outboard Motors distributed by American Honda Motor Co., Inc., Power Equipment Division, 4900 Marconi Drive, Alpharetta, Georgia 30005-8847.

PRODUCTS COVERED BY WARRANTY	LENGTH OF WARRANTY: (FROM DATE OF ORIGINAL PURCHASE)	
	NONCOMMERCIAL/ NONRENTAL	COMMERCIAL/ RENTAL
All Outboard Motors	36 Months	12 Months

TO QUALIFY FOR THIS WARRANTY:

The Honda Outboard Motor must be purchased from American Honda or a dealer authorized by American Honda to sell Honda Outboard Motors in the United States, Puerto Rico, or the U.S. Virgin Islands. This limited warranty applies to the first retail purchaser and each subsequent owner during the applicable warranty time period.

WHAT AMERICAN HONDA WILL REPAIR OR REPLACE UNDER WARRANTY:

American Honda will repair or replace, at its option, any part that is proven to be defective in material or workmanship under normal use during the applicable warranty time period. Warranty repairs and replacements will be made without charge for parts or labor. Anything replaced under warranty becomes the property of American Honda Motor Company, Inc. All parts replaced under warranty will be considered as part of the original product and any warranty on those parts will expire coincidentally with the original product warranty.

TO OBTAIN WARRANTY SERVICE:

You must take your Honda Outboard Motor and proof of the original purchase date, at your expense, to any dealer who is authorized to service Honda Outboard Motors in the United States, Puerto Rico, or the U.S. Virgin Islands, during the dealer's normal business hours. If you are unable to obtain warranty service, or are dissatisfied with the warranty service you receive, take the following steps: First, contact the owner of the dealership involved; normally this should resolve the problem. However, if you should require further assistance, write or call the Honda Marine Customer Relations. Please see *Contacting Honda* page 116 .

TECHNICAL AND CONSUMER INFORMATION

EXCLUSIONS:

THIS WARRANTY DOES NOT EXTEND TO THE FOLLOWING:

- CONDITIONS CAUSED BY LACK OF ROUTINE MAINTENANCE
- PARTS AFFECTED OR DAMAGED BY AN ACCIDENT AND/OR COLLISION
- NORMAL WEAR
- FUEL CONTAMINATION AND WATER ENTERING ENGINE THROUGH THE FUEL INTAKE, AIR INTAKE OR EXHAUST SYSTEM
- USE IN AN APPLICATION FOR WHICH THE OUTBOARD MOTOR WAS NOT DESIGNED, SUCH AS RACING OR COMPETITIVE USE OR ANY OTHER MISUSE OR NEGLIGENCE
- INCORPORATION OF UNSUITABLE ATTACHMENTS OR PARTS
- THE UNAUTHORIZED ALTERATION, IMPROPER INSTALLATION, OR ANY CAUSES OTHER THAN DEFECTS IN MATERIAL OR WORKMANSHIP
- CORROSION TO STEERING SYSTEM OR ELECTRICAL COMPONENTS, CORROSION DUE TO ELECTROLYSIS, WATER BORN FOREIGN CHEMICALS, IMPROPER SERVICE OR CORROSION CAUSED BY DAMAGE OR ABUSE
- REIMBURSEMENT FOR TOWING CHARGES, IN AND OUT OF WATER CHARGES, OR

TECHNICIAN TRAVEL TIME

- GROWTH OF MARINE ORGANISMS ON MOTOR SURFACES, EXTERNAL OR INTERNAL

DISCLAIMER OF CONSEQUENTIAL DAMAGE AND LIMITATION OF IMPLIED WARRANTIES:

AMERICAN HONDA DISCLAIMS ANY RESPONSIBILITY FOR LOSS OF TIME OR USE OF THE OUTBOARD, REVENUE, OR THE EQUIPMENT IN WHICH THE OUTBOARD IS INSTALLED, TRANSPORTATION, COMMERCIAL LOSS, OR ANY OTHER INCIDENTAL OR CONSEQUENTIAL DAMAGE. ANY IMPLIED WARRANTIES ARE LIMITED TO THE DURATION OF THIS WRITTEN LIMITED WARRANTY. Some states do not allow limitations on how long an implied warranty lasts and/or do not allow the exclusion or limitation of incidental or consequential damages, so the above exclusions and limitations may not apply to you. This warranty gives you specific legal rights, and you may also have other rights which vary from state to state.

TECHNICAL AND CONSUMER INFORMATION

ACCESSORIES AND REPLACEMENT PARTS

This warranty is limited to Honda Power Equipment parts, accessories and apparel when distributed by American Honda Motor Co., Inc., 1919 Torrance Blvd., Torrance, California 90501-2746.

PRODUCTS COVERED BY WARRANTY	LENGTH OF WARRANTY: (FROM DATE OF ORIGINAL PURCHASE)	
	NONCOMMERCIAL/ NONRENTAL	COMMERCIAL/ RENTAL
Accessories	12 Months	3 Months
Replacement Parts	6 Months	3 Months

TO QUALIFY FOR THIS WARRANTY:

1. The accessories or replacement parts must be purchased from American Honda, or a dealer, distributor or distributor's dealer authorized by American Honda to sell those products in the United States, Puerto Rico, and the U.S. Virgin Islands.
2. You must be the first retail purchaser. This warranty is not transferable to subsequent owners.

WHAT AMERICAN HONDA WILL REPAIR OR REPLACE UNDER WARRANTY:

American Honda will repair or replace, at its option, any marine product accessories or replacement parts that are proven to be defective in material or workmanship under normal use during the applicable warranty time period. Anything replaced under warranty becomes the property of American Honda Motor Company, Inc. All parts replaced under warranty will be considered as part of the original product and any warranty on those parts will expire coincidentally with the original product warranty. Accessories and replacement parts, installed by a dealer who is authorized by American Honda to sell them, will be repaired or replaced under warranty without charge for parts or labor. If installed by anyone else, accessories and replacement parts will be repaired or replaced under warranty without charge for parts, but any labor charges will be the responsibility of the purchaser.

TECHNICAL AND CONSUMER INFORMATION

TO OBTAIN WARRANTY SERVICE:

You must take the Honda Outboard Motor product accessory or replacement part or the outboard motor or boat on which the accessory or replacement part is installed, and proof of purchase, at your expense, to any Honda Outboard Motor dealer in the United States, Puerto Rico, or the U.S. Virgin Islands who is authorized to sell that product, during the dealer's normal business hours.

If you are unable to obtain warranty service, or are dissatisfied with the warranty service you receive, take the following steps: First, contact the owner of the dealership or distributorship involved; normally this will resolve the problem. However, if you should require further assistance, write or call the Honda Marine Customer Relations Department of American. Please see *Contacting Honda* page 116.

THIS WARRANTY DOES NOT EXTEND TO ACCESSORIES OR PARTS AFFECTED OR DAMAGED BY ACCIDENT AND/OR COLLISION, NORMAL WEAR, USE IN AN APPLICATION FOR WHICH THE PRODUCT WAS NOT DESIGNED OR ANY OTHER MISUSE, NEGLIGENCE, INCORPORATION OR USE OF UNSUITABLE ATTACHMENTS OR PARTS, UNAUTHORIZED ALTERATION, IMPROPER INSTALLATION, OR ANY CAUSES OTHER THAN DEFECTS IN

MATERIAL OR WORKMANSHIP OF THE PRODUCT.

DISCLAIMER OF CONSEQUENTIAL DAMAGE AND LIMITATION OF IMPLIED WARRANTIES:

AMERICAN HONDA DISCLAIMS ANY RESPONSIBILITY FOR LOSS OF TIME OR USE OF THE HONDA OUTBOARD MOTOR, OR THE BOAT ON WHICH THE PRODUCT IS INSTALLED, TRANSPORTATION, COMMERCIAL LOSS, OR ANY OTHER INCIDENTAL OR CONSEQUENTIAL DAMAGE. ANY IMPLIED WARRANTIES ARE LIMITED TO THE DURATION OF THIS WRITTEN WARRANTY. Some states do not allow limitations on how long an implied warranty lasts and/or do not allow the exclusion or limitation of incidental or consequential damages, so the above exclusions and limitations may not apply to you. This warranty gives you specific legal rights, and you may also have other rights which vary from state to state.

Emission Control System Warranty

Your new Honda outboard engine complies with both the U.S. EPA and State of California emission regulations. American Honda provides the same emission warranty coverage for outboard engines sold in all 50 states.

YOUR WARRANTY RIGHTS AND OBLIGATION

California

The California Air Resources Board and American Honda Motor Co., Inc. are pleased to explain the emission control system warranty on your 2001 and later Honda outboard engine. In California, new outboard engines must be designed, built and equipped to meet California's stringent anti-smog emission standards in addition to the U.S. EPA emissions standards.

Other States

In other areas of the United States your outboard engine must be designed, built and equipped to meet the U.S. EPA Emission Standard for spark ignited marine engines.

All States

American Honda Motor Co., Inc. must warranty the emission control system on your outboard engine for the period of time listed below provided there has been no abuse, neglect or improper maintenance of your outboard engine. Where a warranty condition exists, American Honda Motor Co., Inc. will repair your outboard engine at no cost to you including diagnosis, parts and labor. Your emission control system may include such parts as the carburetor or fuel injection system and catalytic converter. Also included may be hoses, connectors and other emission-related assemblies.

MANUFACTURER'S EMISSION CONTROL SYSTEM WARRANTY COVERAGE:

The 2001 and later outboard engines are warranted for four years or 250 hours of operation, whichever comes first. However, warranty coverage based on the hourly period is only permitted for outboard engines equipped with appropriate hour meters. If any emission-related part on your outboard engine is defective under warranty, the part will be repaired or replaced by American Honda Motor Co., Inc.

TECHNICAL AND CONSUMER INFORMATION

OWNER'S WARRANTY RESPONSIBILITY:

As the outboard engine owner, you are responsible for the performance of the required maintenance listed in your owner's manual. American Honda Motor Co., Inc. recommends that you retain all receipts covering maintenance on your outboard engine, but American Honda Motor Co., Inc. cannot deny warranty solely for the lack of receipts or for your failure to ensure the performance of all scheduled maintenance. As the outboard engine owner, you should, however, be aware that American Honda Motor Co., Inc. may deny you warranty coverage if your outboard engine or a part has failed due to abuse, neglect, improper maintenance, or unapproved modifications. You are responsible for presenting your outboard engine to a Honda Marine dealer as soon as a problem exists. The warranty repair should be completed in a reasonable amount of time, not to exceed 30 days. If you have any questions regarding your warranty rights and responsibilities, you should contact American Honda Motor Co., Inc., Marine Division Customer Relations Office. Please see *Contacting Honda* page 116.

WARRANTY COVERAGE:

Honda outboard engines manufactured after June 1, 2000 are covered by this warranty for a period of four years or 250 operating hours, whichever comes first, from the date of delivery to the retail purchaser. This warranty is transferred to each subsequent purchaser for the duration of the warranty period. Warranty repairs will be made without charge for diagnosis, parts and labor. All defective parts replaced under this warranty become the property of American Honda Motor Co., Inc. A list of warranty parts is on page 126. Normal maintenance items, such as spark plugs and filters, that are on the warranted parts list are warranted up to their required replacement interval only. American Honda Motor Co., Inc. is also liable for damages to other engine components caused by a failure of any warranted part during the warranty period. Only Honda approved replacement parts will be used in the performance of any warranty repairs and they will be provided without charge to the owner. The use of replacement parts not equivalent to the original parts may impair the effectiveness of your engine's emission control system. If such a replacement part is used in the repair or maintenance of your engine, and an authorized Honda Marine dealer determines it is defective or causes a failure of a warranted part, your claim for your engine may be denied. If the part in question is not related to the reason that your engine requires repair, your claim will not be denied.

TECHNICAL AND CONSUMER INFORMATION

TO OBTAIN WARRANTY SERVICE:

You must take your Honda outboard engine, along with your sales registration card or other proof of original purchase date, at your expense, to any Honda Marine dealer who is authorized by American Honda Motor Co., Inc. to sell and service that Honda marine product during his normal business hours. Claims for repair or adjustment found to be caused solely by defects in material or workmanship will not be denied because the engine was not properly maintained and used. If you are unable to obtain warranty service, or are dissatisfied with the warranty service you received, contact the owner of the dealership involved. Normally this should resolve your problem. However, if you require further assistance, write or call the Honda Marine Customer Relations Office of American Honda Motor Co., Inc.

EXCLUSIONS:

FAILURES OTHER THAN THOSE RESULTING FROM DEFECTS IN MATERIAL OR WORKMANSHIP ARE NOT COVERED BY THIS WARRANTY. THIS WARRANTY DOES NOT EXTEND TO EMISSION CONTROL SYSTEMS OR PARTS WHICH ARE AFFECTED OR DAMAGED BY OWNER ABUSE, NEGLIGENCE, IMPROPER MAINTENANCE, MISUSE, MISFUELING, IMPROPER STORAGE, ACCIDENT AND/OR COLLISION. THE INCORPORATION OF, OR USE

OF, UNSUITABLE ATTACHMENTS, OR THE UNAUTHORIZED ALTERATION OF ANY PART. THIS WARRANTY DOES NOT COVER REPLACEMENT OF EXPENDABLE MAINTENANCE ITEMS MADE IN CONNECTION WITH REQUIRED MAINTENANCE SERVICE AFTER THE ITEM'S FIRST SCHEDULED REPLACEMENT AS LISTED IN THE MAINTENANCE SECTION OF THE PRODUCT OWNER'S MANUAL, SUCH AS: SPARK PLUGS AND FILTERS.

DISCLAIMER OF CONSEQUENTIAL DAMAGE AND LIMITATION OF IMPLIED WARRANTIES:

American Honda Motor Co., Inc. disclaims any responsibility for incidental or consequential damages such as loss of time or the use of outboard engine, or any commercial loss due to the failure of the equipment; and any implied warranties are limited to the duration of this written warranty. This warranty is applicable only where the California or U.S. EPA emission control system warranty regulation is in effect.

TECHNICAL AND CONSUMER INFORMATION

EMISSION CONTROL SYSTEM WARRANTY PARTS:

SYSTEMS COVERED BY THIS WARRANTY:	PARTS DESCRIPTION
Fuel Metering	Carburetor assembly, Throttle body, Fuel injector, Fuel pump, Fuel pressure regulator, Throttle position sensor, Intake air temperature sensor, Engine temperature sensor, Manifold absolute pressure sensor, Idle air control valve, Barometric pressure sensor, Fuel line solenoid valve, Intake manifold, Intake valves, and Oxygen sensor or Air fuel ratio sensor
Air Induction	Air intake duct, Crankcase breather tube, Positive crankcase ventilation valve, Vapor separator, Intake manifold tuning valve (Intake air bypass control valve)
Ignition	Flywheel magneto, Ignition pulse generator, Ignition coil assembly, Ignition control module, Engine control module, Crankshaft position sensor, Spark plug cap, Spark plug*, Knock sensor, and Camshaft position sensor
Lubrication system	Oil pump and internal parts
Crankcase Emission Control	Oil filler cap
Exhaust	Exhaust manifold and Exhaust valves
VTEC System	VTEC valve
Miscellaneous Parts	Tubing, fittings, seals, gaskets, and clamps associated with these listed systems.
*Covered up to the first required replacement only. See the Maintenance Schedule in the owner's manual.	

INDEX

Anodes.....	29	Distributor's Limited Warranty – 2006	119
Replacement.....	82	EMERGENCY STARTING.....	48
ARE YOU READY TO GET UNDER WAY ?	37	Emission Control System Information	108
ATTACHMENT	33	Emission Control System Warranty.....	121
Battery	106	Emergency Stop Switch and Switch Clip	17
Connections.....	34	SH, LH, SHG and LHT Types (long tiller handle)....	17
BATTERY WILL NOT CHARGE AND		SRG, LRG, SRT and LRT Types (remote control)	
ELECTRIC STARTER WILL NOT		(side-mount type)	20
OPERATE.....	100	Engine	
BEFORE OPERATION.....	37	Cover	
BOAT TRANSOM REQUIREMENTS	32	Latches	24
BREAK-IN PROCEDURE.....	39	REMOVAL AND INSTALLATION.....	70
Carburetor Modification for High Altitude		Oil	
Operation.....	106	Change.....	72
Common Controls	23	Level Check	71
COMPONENT AND CONTROL LOCATIONS	11	Recommendations	73
CONSUMER INFORMATION	116	ENGINE OVERHEATS	99
CONTROL AND FEATURE IDENTIFICATION		ENGINE WILL NOT START.....	96
CODES.....	10		
CONTROLS.....	16		
CONTROLS AND FEATURES	10		
Cooling System Indicator.....	28		
CRUISING.....	56		
Customer Service Information.....	115		

INDEX

Fast Idle Lever (side-mount type).....	21	Ignition Switch	
Fuel		SHG and LHT Types (long tiller handle)	16
Filler Cap Vent Knob	30	SRG, LRG, SRT and LRT Types (remote control)	
Filter Inspection and Replacement.....	79	(side-mount type)	20
Gauge.....	26	IMPORTANT SAFETY INFORMATION.....	7
HOSE CONNECTIONS	42	INDICATORS.....	27
PRIMING	43	INSTALLATION.....	32
Priming Bulb	31	POSITION.....	32
RECOMMENDATIONS.....	78	POWER REQUIREMENTS.....	32
Fuse Replacement	100	INSTRUMENTS.....	26
Gearshift Lever.....	18	IS YOUR OUTBOARD MOTOR	
Gearshift/Trottle Control Lever		READY TO GO ?	37
SRG, LRG, SRT and LRT Types (remote control)		Lubrication Points	74
(side-mount type)	22	MAINTENANCE SAFETY	65
GEARSHIFTING AND THROTTLE OPERATION ...	53	MAINTENANCE SCHEDULE	67
SH, LH, SHG and LHT Types (long tiller handle)...	53	MANUAL RELIEF VALVE.....	24, 70
SRG, LRG, SRT and LRT Types (remote control)...	54	MOORING, BEACHING, LAUNCHING.....	61
HARD STARTING OR STALLS AFTER			
STARTING	98		
Honda Publications	116		

Oil Pressure Indicator 27

OIL PRESSURE INDICATOR LIGHT GOES OFF AND ENGINE SPEED IS LIMITED 101

OPERATION 39

OTHER FEATURES 29

OUTBOARD MOTOR SAFETY 7

Overheat Indicator 28

OVERHEAT INDICATOR LIGHT COMES ON AND ENGINE SPEED IS LIMITED 102

Overrev Limiter 30

Oxygenated Fuels 107

PORTABLE FUEL TANK 30, 42

Portable Fuel Tank and Filter Cleaning 81

Power Tilt Switch 23

Power Trim/Tilt Switch 23

Propeller Replacement 84

Recoil Starter Grip (SH and LH types) 16

REFUELING 77

REMOVAL FROM STORAGE 91

SAFE OPERATING PRECAUTIONS 39

SAFETY LABEL LOCATIONS 9

Serial Number Locations 105

SERVICING YOUR OUTBOARD MOTOR 64

SHALLOW WATER OPERATIONS 58

SPARE EMERGENCY STOP SWITCH CLIP AND EMERGENCY STARTER ROPE 66

Spark Plug Service 75

Specifications 112

Star Label 110

STARTING THE ENGINE 43

SH, LH, SHG and LHT Types (long tiller handle).... 43

SRG, LRG, SRT and LRT Types (remote control)... 46

STEERING..... 55

SH, LH, SHG and LHT Types (long tiller handle).... 55

SRG, LRG, SRT and LRT Types (remote control)... 55

Steering Friction Adjuster 18, 55

STOPPING THE ENGINE..... 51

Emergency Engine Stopping..... 51

Normal Engine Stopping 51

STORAGE 85

STORAGE PRECAUTIONS..... 90

STORAGE PREPARATION..... 85

Cleaning and Flushing 85

Engine oil 90

Fuel 88

SUBMERGED MOTOR 103

INDEX

Tachometer	26
TAKING CARE OF UNEXPECTED PROBLEMS.....	95
TECHNICAL AND CONSUMER INFORMATION.....	105
TECHNICAL INFORMATION.....	105
THE IMPORTANCE OF MAINTENANCE	64
Throttle Friction Adjuster	18
Throttle Grip.....	17
Tilt Lever (manual tilt/SH and LH types).....	19
(gas assist tilt/SHG, SRG and LRG types)	19
Tilt Lock Lever (SHG, LHT, SRG, LRG, SRT and LRT types).....	24
TOOL KIT.....	66
TRANSOM ANGLE ADJUSTMENT	34, 40
Transom Angle Adjusting Rod	25
TRANSPORTING	92
WITH OUTBOARD MOTOR INSTALLED ON BOAT	92
WITH OUTBOARD MOTOR REMOVED FROM BOAT	93
Trim Meter (optional equipment)	26
Trim Tab.....	25, 58
TRIM TAB ADJUSTMENT	69

WIRING DIAGRAMS.....	Inside Back Cover
----------------------	-------------------

WIRING DIAGRAM

LONG TILLER HANDLE, MANUAL TILT TYPE
(with recoil starter and 4A charge coil type)

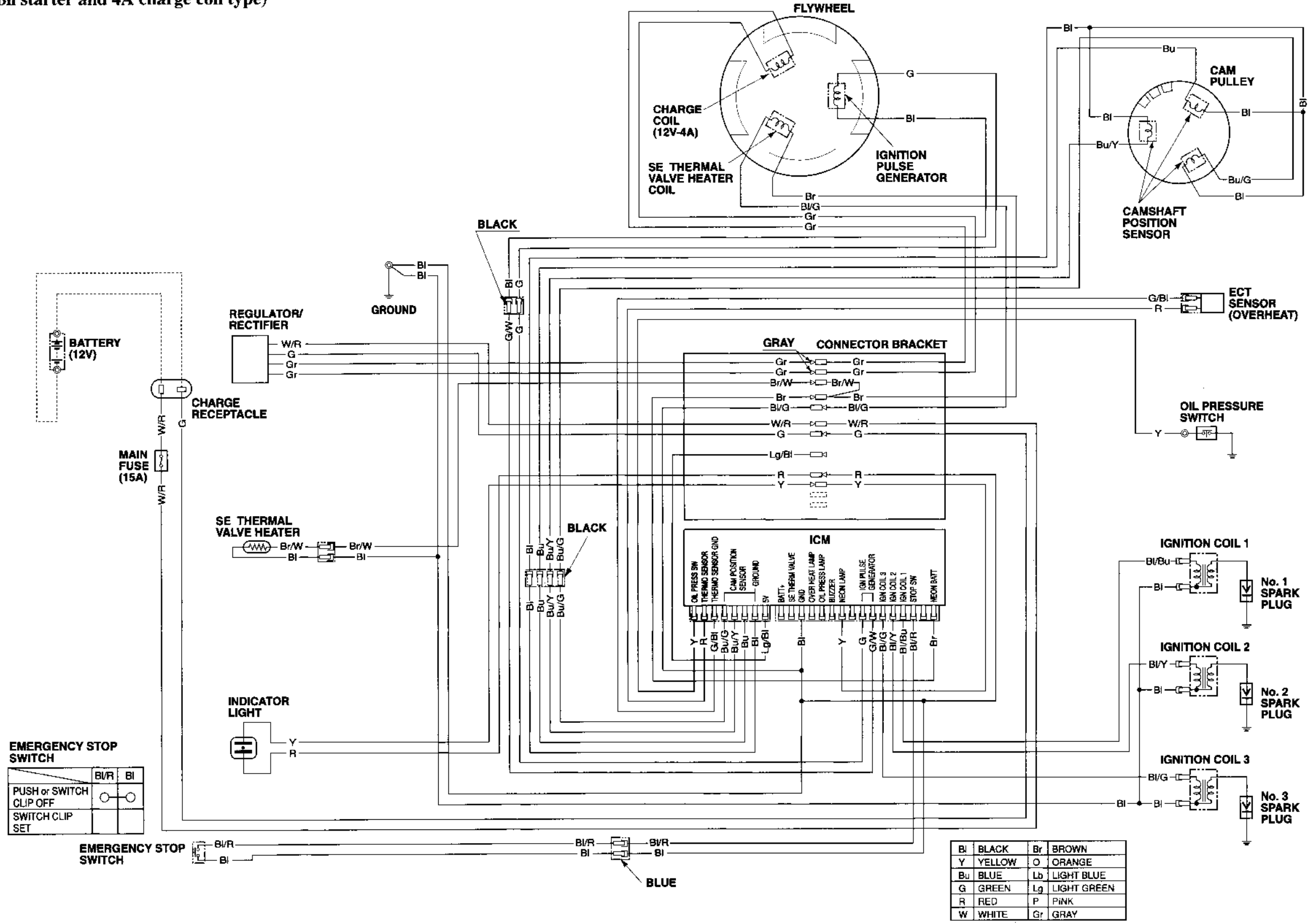

EMERGENCY STOP SWITCH

	Bl/R	Bl
PUSH or SWITCH CLIP OFF	○	○
SWITCH CLIP SET		

Bl	BLACK	Br	BROWN
Y	YELLOW	O	ORANGE
Bu	BLUE	Lb	LIGHT BLUE
G	GREEN	Lg	LIGHT GREEN
R	RED	P	PINK
W	WHITE	Gr	GRAY

WIRING DIAGRAM

LONG TILLER HANDLE, GAS ASSIST TILT TYPE

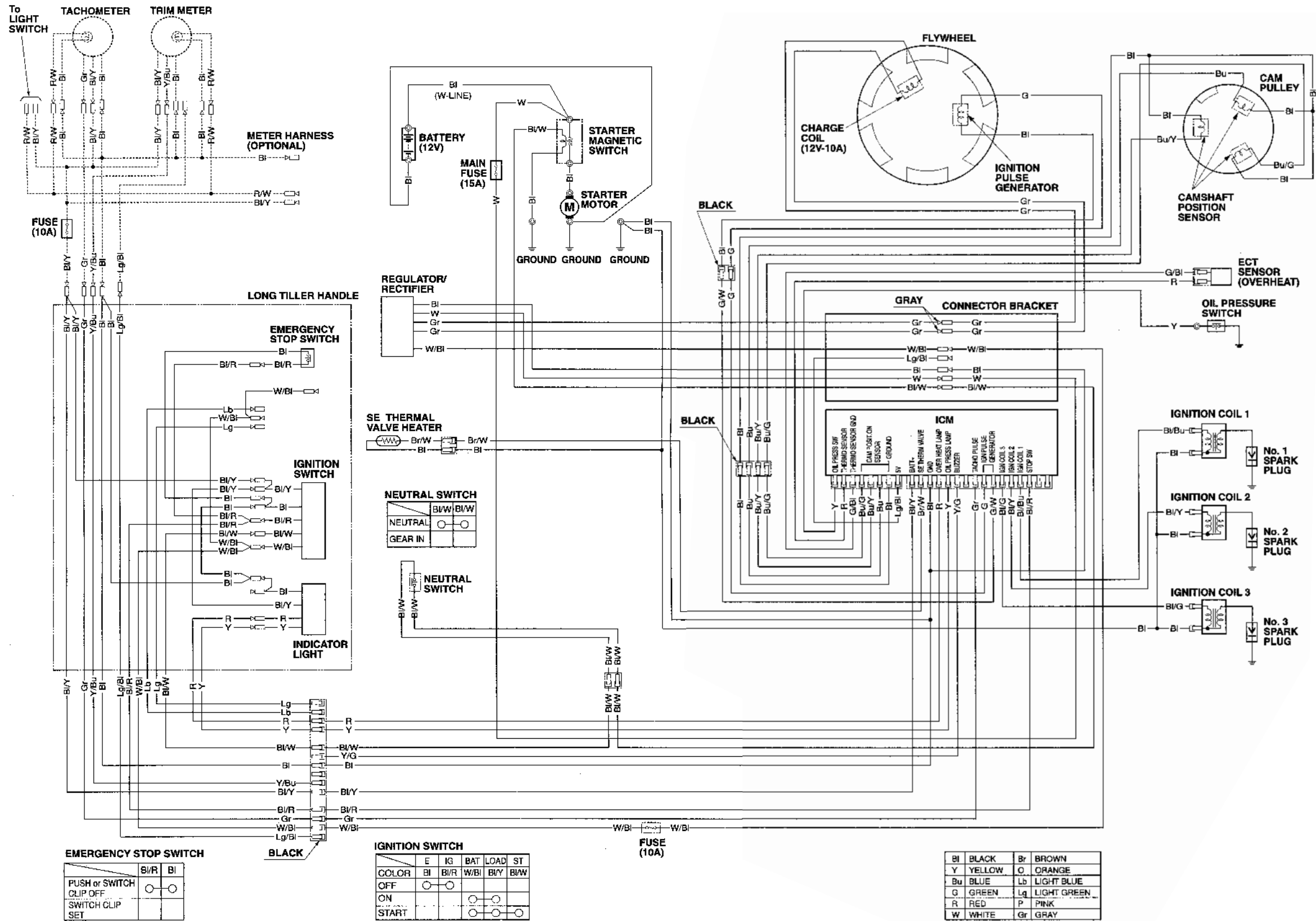

WIRING DIAGRAM

LONG TILLER HANDLE, POWER TRIM/TILT TYPE

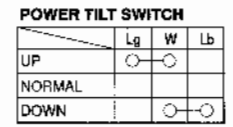
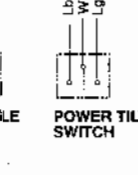
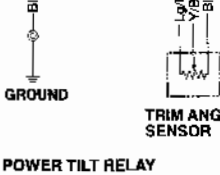
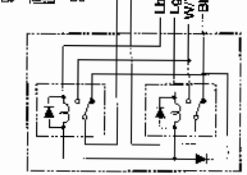
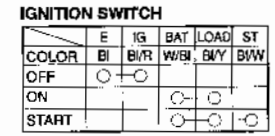
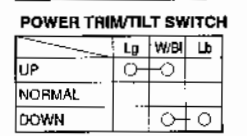
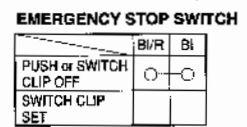
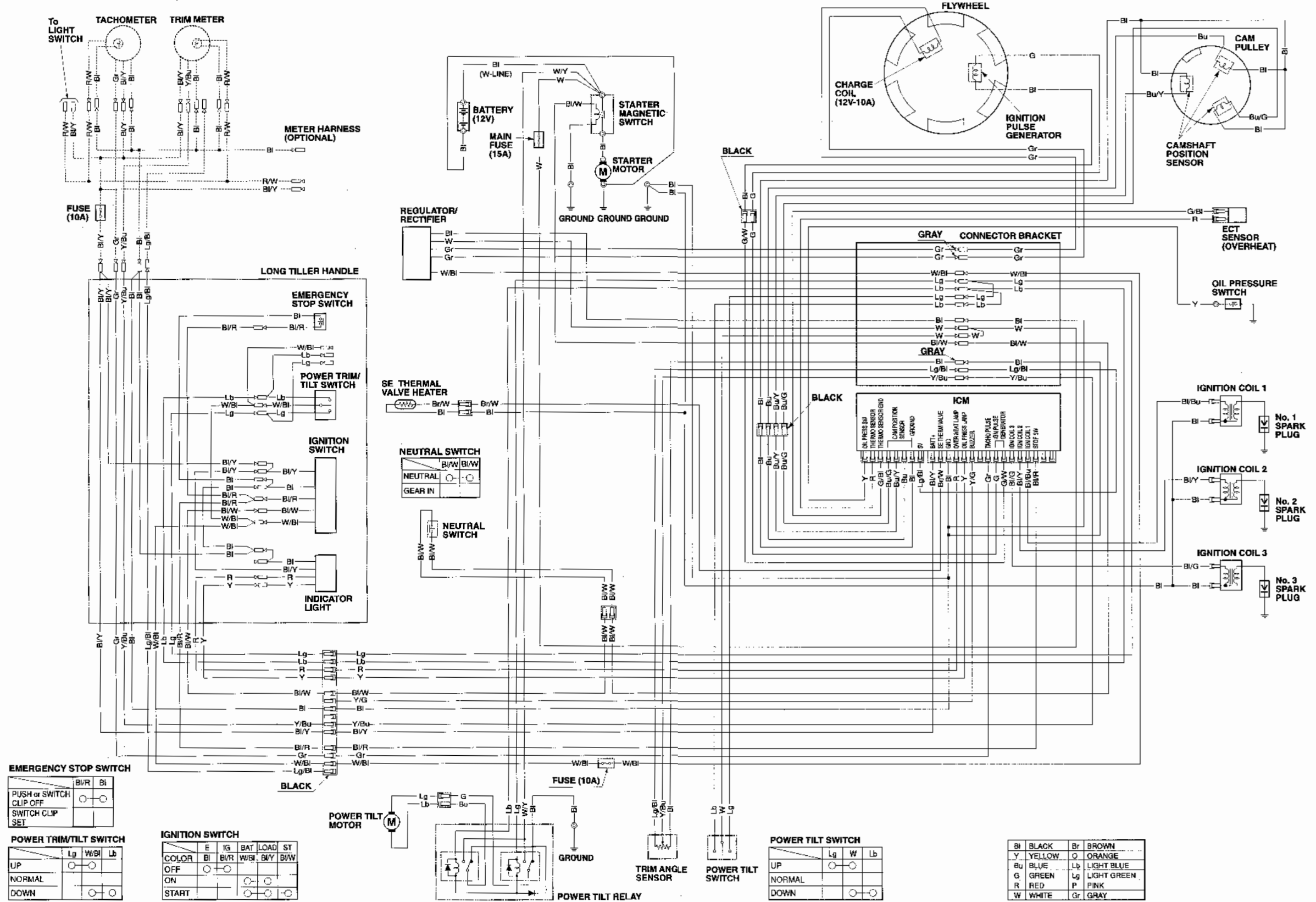

BI	BLACK	Br	BROWN
Y	YELLOW	O	ORANGE
Bu	BLUE	Lb	LIGHT BLUE
G	GREEN	Lg	LIGHT GREEN
R	RED	P	PINK
W	WHITE	Gr	GRAY

WIRING DIAGRAM

REMOTE CONTROL, GAS ASSIST TILT TYPE

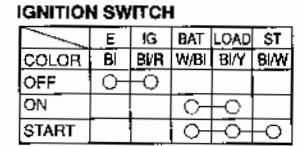
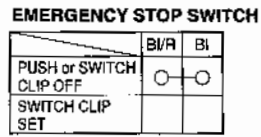
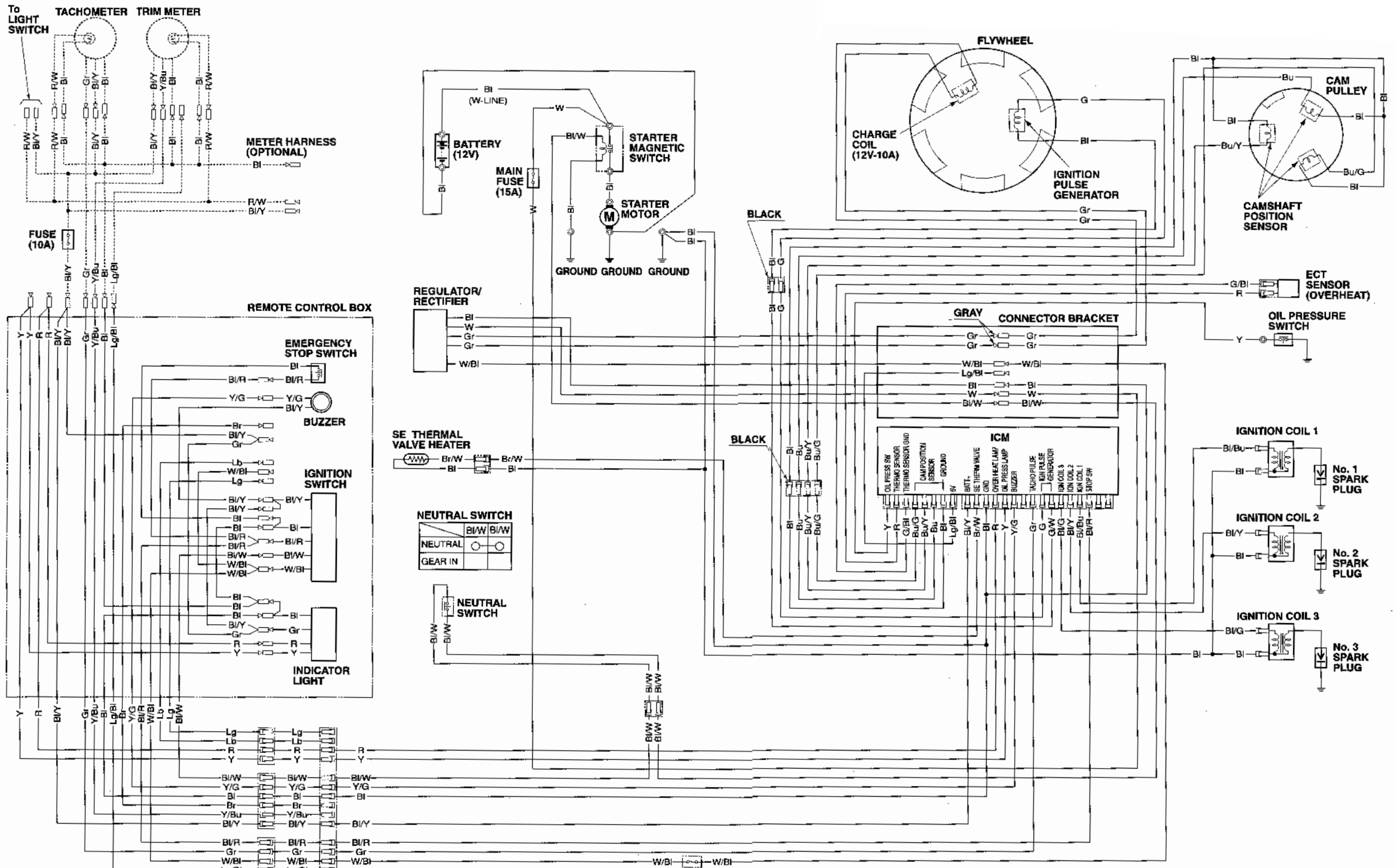

BI	BLACK	Br	BROWN
Y	YELLOW	O	ORANGE
Bu	BLUE	Lb	LIGHT BLUE
G	GREEN	Lg	LIGHT GREEN
R	RED	P	PINK
W	WHITE	Gr	GRAY

WIRING DIAGRAM

REMOTE CONTROL, POWER TRIM/TILT TYPE

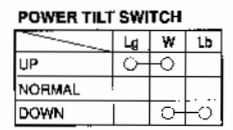
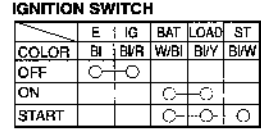
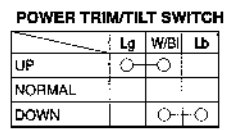
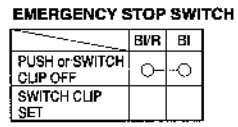
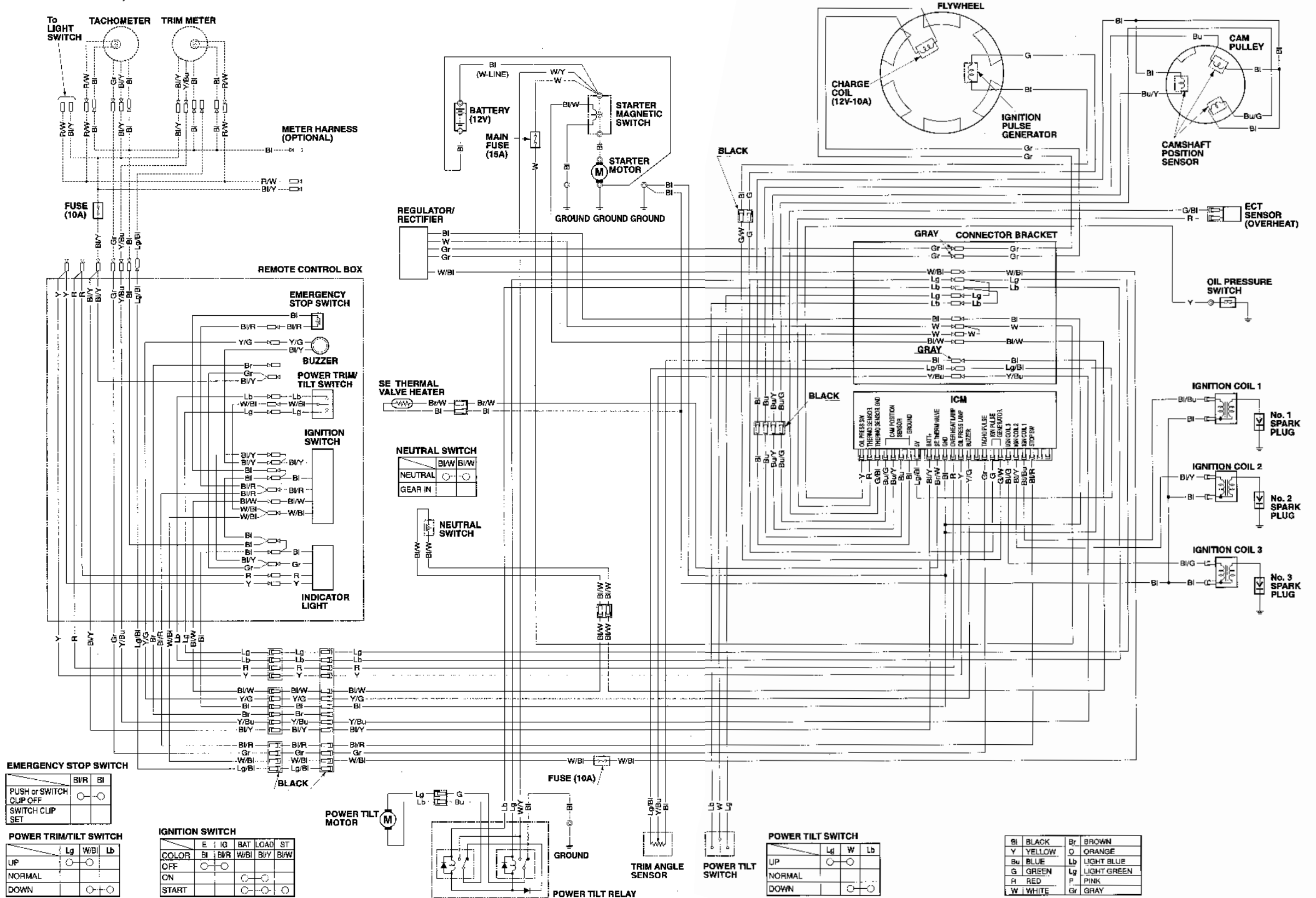

BI	BLACK	Br	BROWN
Y	YELLOW	O	ORANGE
Bu	BLUE	Lb	LIGHT BLUE
G	GREEN	Lg	LIGHT GREEN
R	RED	P	PINK
W	WHITE	Gr	GRAY

HONDA

The Power of Dreams

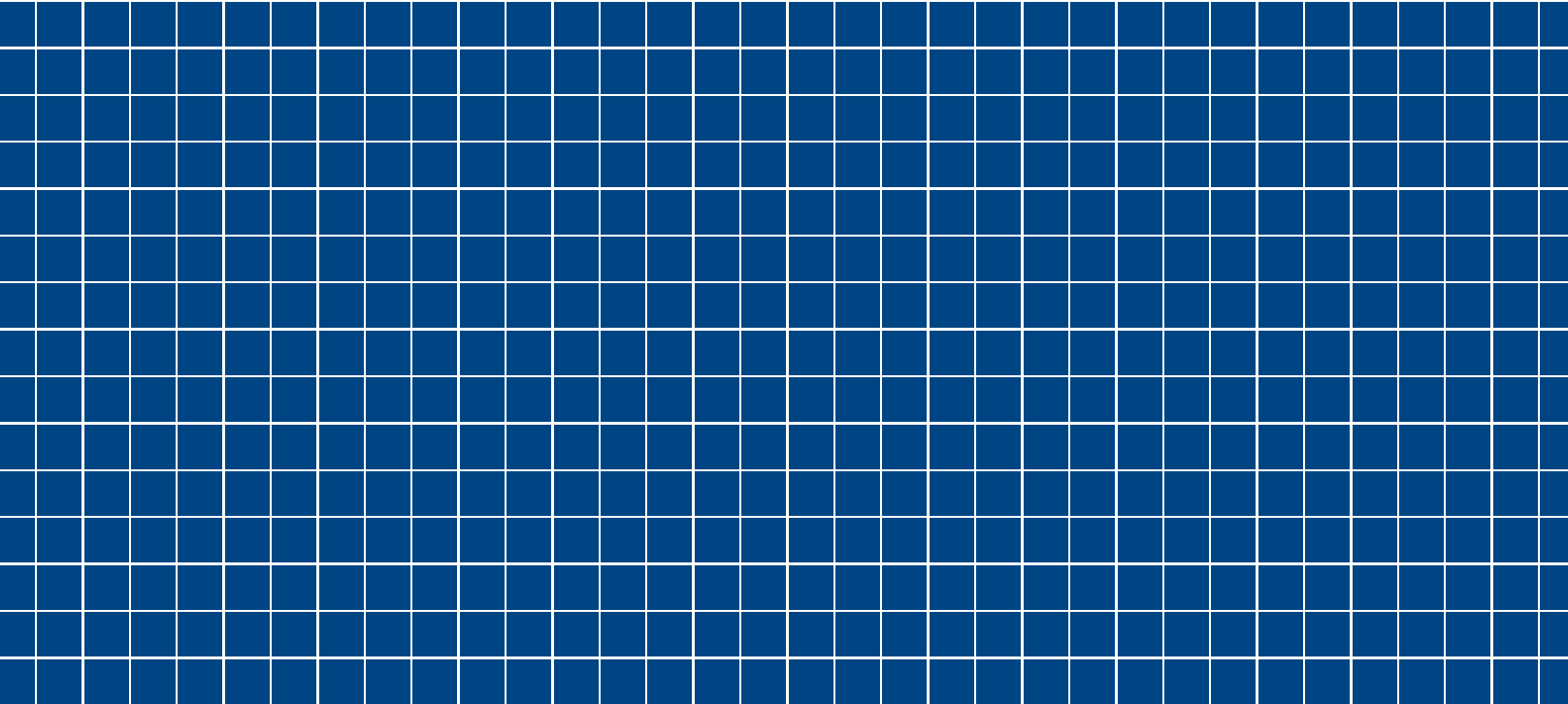

31ZW26
00X31-ZW2-6030



AH 英 Y

HC 500.2005.03
Printed in Japan

McGrp.Ru



Сайт техники и электроники

Наш сайт McGrp.Ru при этом не является просто хранилищем [инструкций по эксплуатации](#), это живое сообщество людей. Они общаются на форуме, задают вопросы о способах и особенностях использования техники. На все вопросы очень быстро находят ответы от таких же посетителей сайта, экспертов или администраторов. Вопрос можно задать как на форуме, так и в специальной форме на странице, где описывается интересующая вас техника.